



Q5

Audi Q5 | Q5 hybrid

Audi
Truth in Engineering



If it was this easy, it wouldn't be an Audi.

Obsession



IMAGINE DEVOTING YOUR LIFE TO BUILDING YOUR MODEL.

When you were a kid, you probably felt quite proud when you completed a model kit. We understand. At Audi, it takes countless hours for a single Audi to go from idea to design to roadworthy, and that's time we are very proud to devote. Our obsession for detail,

commitment to premium fit and finish and passion for unparalleled engineering go into every model. It's the kind of discipline that the word "painstaking" was invented to describe. Not to say it's a chore—no, assembling an Audi is a labor of love, and it shows every time you sit in one, engage the ignition and nudge the accelerator. Creating an Audi isn't easy, but the results help define what Audi means to the people who drive one.

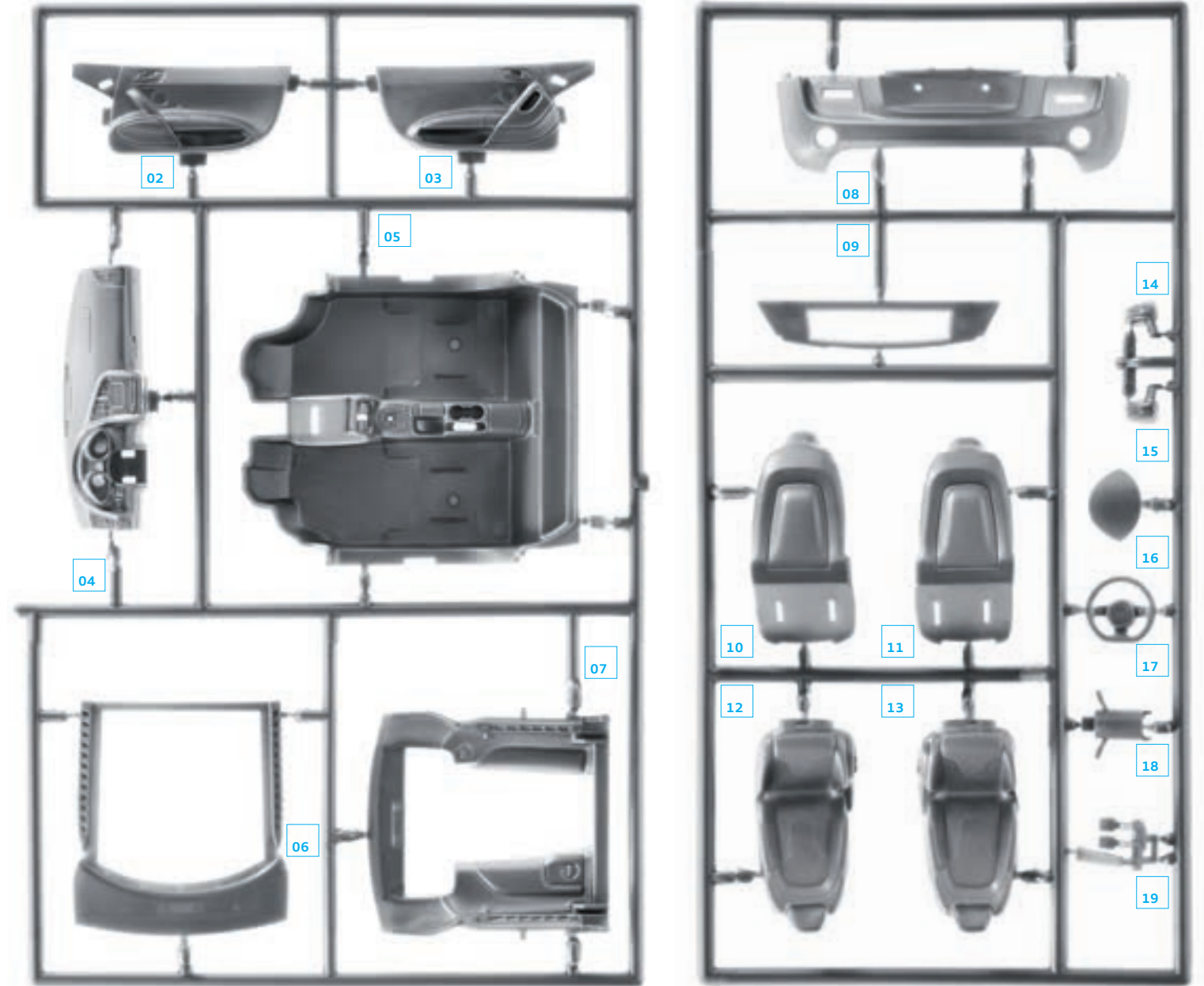



The door of perception.

OUR REPUTATION HINGES ON THE QUALITY OF THINGS YOU DON'T SEE.

It's said that, when one door closes, another one opens. It sounds as if whoever said it spent some time at an Audi research and development facility. After all, while you'll open and close the door on your Audi thousands of times without thinking about it, we've obsessed about it for you, in detail. Not just about the reliability of it opening and

closing, but on the proper weight that will make it more pleasing to close. How the locks should click when they are engaged. The optimal acoustic placement for the speaker port. There are the hinges too, of course. And the door itself, which we designed to take the brunt of side-impact collisions, and several dozen other safety considerations (to say nothing of the countless other components, processors, sensors, window features and the inner workings most people will never see). Our doors are more than a symbol of welcoming you into your vehicle, they are products of Audi engineering, and the very perception of Audi hinges on them as much as our hinges help support the door.

ACOUSTIC ENHANCEMENTS

We use soft mounts on our window regulator and a sound-absorbing backing within the door cavity itself to make the cabin even quieter.

INNOVATIVE DESIGN

By using fully pressed aluminum doors in the Audi A6, the door structures were reduced by an astonishing 44 lb compared to the previous model.

SPEAKER PLACEMENT

Optimal speaker placement helps deliver the most extraordinary sound you can find in the automotive space.

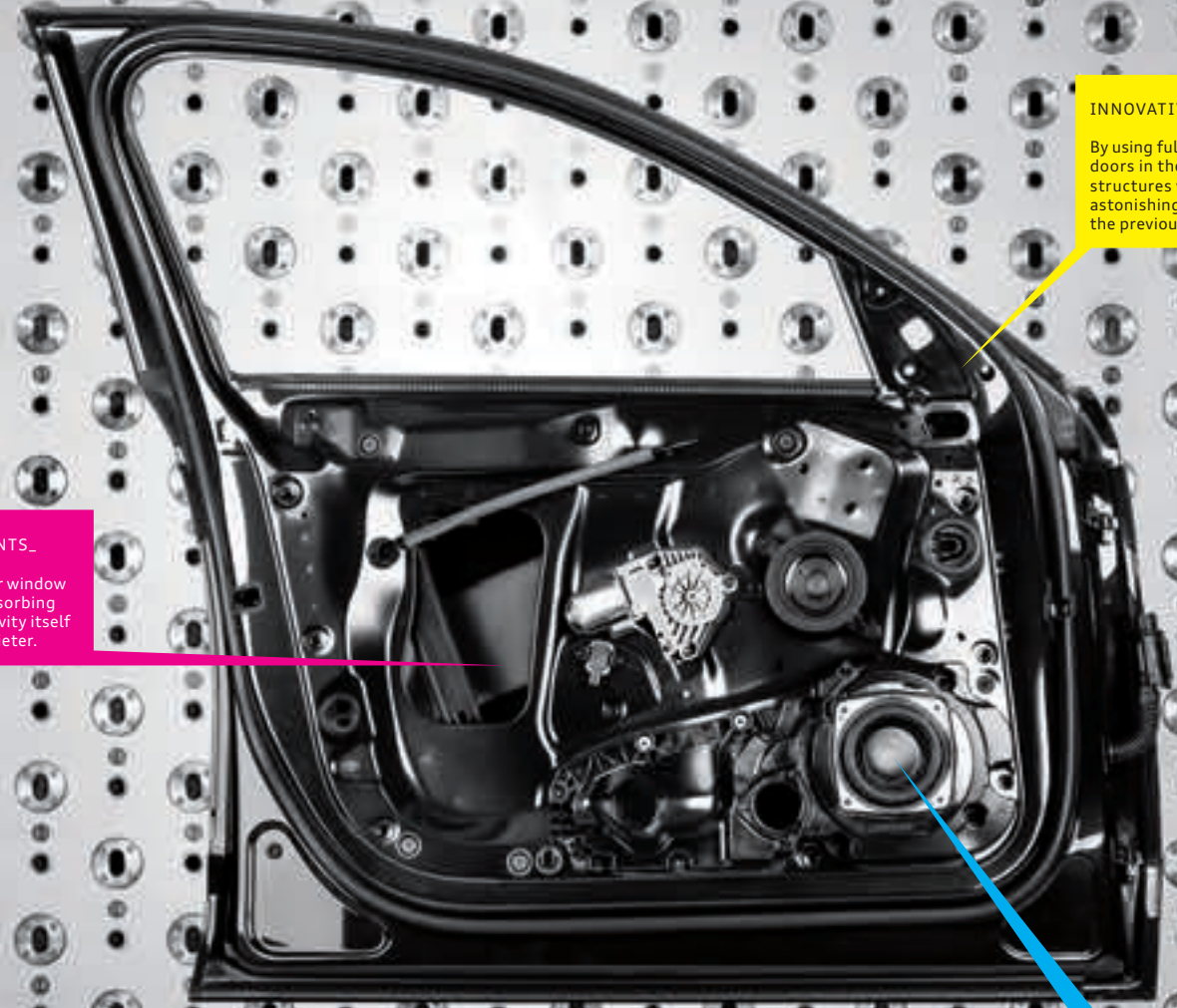

When we think of a good idea, it sticks.



SURFACES

WET
DRY
SLIPPERY
UNEVEN

Torque is distributed to all four wheels in varying amounts.

Torque vectoring

By independently braking the inside cornering wheels, torque is then transferred to the outside cornering wheels. This intelligent application of power, known as torque vectoring, is available on select quattro® models and helps promote neutral handling by calculating the driver's steering input and desired level of acceleration.

Sport differential

To help ensure high cornering agility, the available sport differential uses torque vectoring, and then adds to that by mechanically applying additional torque to the outside rear cornering wheel. Through an electrohydraulic multiplate clutch pack and gear-set, the outside rear cornering wheel speed is increased by as much as 10%.

CORNERS

CURVES
MOUNTAINS
OBSTACLES
HANDLING
UNEXPECTED

Impressive stability, more assured road-holding, enhanced agility and improved steering precision.

TRACTION

ACCELERATION
TOWING
SNOW
CRUISING
GRAVEL

quattro® directs the amount of torque required to suit the job at hand.

quattro® HAS MAINTAINED ITS GRIP ON OUR THINKING AND THE ROADS WE TRAVEL.

For more than 30 years, Audi has been focused on quattro® all-wheel drive. During that time, it has evolved into an overarching idea of performance, a technological system of ratios, power delivery and driving dynamics working seamlessly together, orchestrated through the drivetrain, providing power where and when it is needed most. In

many ways, this has been a three-decade drive, from the Alps to the autobahn—and points beyond. You've seen quattro® capabilities in the way we dominated the World Rally Championship for years, in the grip you have in inclement weather, and in the variable power distribution you enjoy in good conditions.¹ For more than 30 years, and with over five million quattro® systems on the road, we have continued to refine the technology, developing an available rear sport differential to help maximize performance and available torque vectoring to assist with cornering traction while helping to improve handling. We've boldly stuck to what worked while the world was trying to catch up, and we built on it.

¹ When driving during cold, rainy, snowy or icy weather conditions, ensure that your vehicle is equipped with appropriate all-season or winter tires. Even with appropriate tires, you must always drive in a manner appropriate for the weather, visibility and road conditions.

The obsessive engineering of maximum fitness.



ENGINEERING POWER IS MORE THAN JUST ADDING MUSCLE.

There is an art to fitness. Yes, there are some who go for the massive, sculptured muscle look. But there is something more compelling out there for those with more refined tastes. The kind of sculpted efficiency found in Audi engines elevates the driving experience through smaller, finely tuned forced-

induction engines. For the drive to feel lean and precise, we've shaved off unwanted pounds. Sure, large numbers might distract some, but a champion impresses with its grace, power and athletic balance—captured in the right suspension setting, or a torque-vectoring corner. Audi engineers taste power that celebrates a true dedication to craft. It means strength that pulses at the moment of acceleration, provides a true, quick response as you change lanes, and turns the most routine cloverleaf into a joyful application of performance handling¹. This is the art of maximum fitness, to the point where others just feel a little flabby.

FSI[®]

The FSI direct injection fuel system directly injects fuel into the combustion chambers at precisely managed times and depths. What that means for drivers is that a fully homogenized intake charge helps increase power while also reducing fuel consumption and emissions, making efficiency more powerful.

TFSI[®]

At Audi, TFSI represents a combination of two of the brand's core areas of expertise—direct injection and forced induction. By adding turbocharging or supercharging to FSI direct injection, the pressurized intake charge is cooled by directly injected fuel, thus achieving efficiency and performance combined with higher compression ratios—previously only attainable by naturally aspirated engines².

TDI[®]

A turbocharged, fuel-sipping variant, our TDI[®] clean diesel engines deliver uncompromising Audi performance with bold efficiency¹. Yes, it gets better mileage per gallon than comparable gasoline engines²; but it also produces more low-end torque, which is best expressed in the elasticity you have when passing in the 30- to 60-mph range.

¹ Always obey all speed and traffic laws.
² See www.fueleconomy.gov for EPA estimates and emissions data. Your mileage and emissions will vary and depend on several factors, including your driving habits and vehicle condition.

ELEPHANT SKULL_

How nature solved the apparent conundrum of an elephant's skull didn't escape the notice of Heinrich Timm, the longtime lead engineer for Audi. The weight of the tusks and the general size of an elephant's head would seem to make it impossible for the animal to actually be able to carry it. But the design genius behind the elephant's skull is to make it lightweight yet sturdy. Its predominantly hollow design is buffered by thin, connective bone walls, which act as strong, weight-bearing cells. Audi designers used that idea when building our aluminum and steel structures. Reducing weight, yet enabling strength.



ultra



13
26.982

AU

ALUMINUM_

Our large aluminum castings are a telling example of ultra lightweight technology. Primarily used in high-stress areas, these castings achieve exceptional rigidity while also allowing for freedom of design, all while remaining extremely lightweight!

How studying elephant skulls makes for superior handling.

THE ELEGANT STRUCTURE OF NATURE BECOMES A BLUEPRINT OF EFFICIENCY.

It seems strange to say that, while we build strong, complex and high-performing machines, we're naturalists at heart. Then again, it might not be that unusual, seeing how nature itself builds strong, complex and high-performing machines as well. When we developed the thinking behind our ultra® lightweight technology initiative,

we knew that nature would serve as an inspiration to greater structural efficiency. Take the structure of the elephant skull pictured here. It has to be lightweight, yet capable of carrying a heavy load. It's porous, but its structure is such that it enhances its stability and strength. We do the same, for example, with aluminum. Positioned one way, aluminum materials can be flexible. Positioned another, they are strong and rigid, and help give better support. We also looked to bamboo, which is strong at the conjoined areas (nodes), and flexible along its stem. Our designs allow for both rigidity and flexibility where each is most needed, and for efficiency overall. As we continue to develop strategies to improve the performance aspects and efficiency of our vehicles, we don't shy away from the world around us? We boldly engage it even closer still.

1. Features and technologies listed are not available on all models. 2. See www.fueleconomy.gov for EPA estimates and emissions data. Your mileage and emissions will vary and depend on several factors, including your driving habits and vehicle condition.



Just talk to us, baby.



AUDI CONNECT® REALLY GETS WHAT YOU ARE SAYING.

Share what's on your mind. Looking for a great Chinese food place? We'll help you get there. Thinking about a rest stop? We'll locate the nearest gas station for you, and even give you the price of their fuel. In fact, in your Audi, just say the word, and we'll help you find almost anything, even your home phone number. With available Audi connect with Google

Voice™ command capabilities, we've developed a way to let you articulate your desires, even if that's just finding the closest burger stand or the best hotel.¹ MMI® navigation plus with Audi connect helps integrate networking capabilities on the go, along with Google Earth™ with 3D satellite imagery, to help you avoid traffic (and possibly saying things you might regret)² Audi connect also provides fast data transfer speeds and Wi-Fi® connectivity for up to eight passenger devices to help you stay informed. It offers a full suite of services and interactivity, and, yes, even the closest Szechuan restaurant, which you can find by using its Google™ Local Search capabilities. Best of all, you don't even have to say "Thank you," even if we appreciate it when you do.

1. Always pay careful attention to the road, and do not drive while distracted. The features and technologies discussed above are optional, may require an additional subscription with separate terms and conditions, and should be used only when it is safe and appropriate. The Wi-Fi® hotspot feature is intended for passenger use only. Features and technologies listed are not available on all models. The voice control feature is not available on Cabriolet or Roadster models. 2. MMI® navigation plus depends on signals from the worldwide Global Positioning Satellite network. The vehicle's electrical system and existing wireless and satellite technologies must be available and operating properly for the system to function. The system is designed to provide you with suggested routes in locating addresses, destinations and other points of interest. Changes in street names, construction zones, traffic flow, points of interest and other road system changes are beyond the control of Audi of America, Inc. Complete detailed mapping of lanes, roads, streets, toll roads, highways, etc., is not possible, therefore you may encounter discrepancies between the mapping and your actual location. Please rely on your individual judgment in determining whether or not to follow a suggested MMI® navigation plus route. For mapping updates please see your Audi dealer or call 1-800-FOR-AUDI for details. Features and technologies listed are not available on all models.



Hey, bright eyes.



DESIGNING A WINDOW TO OUR SOUL.

Even in the dark, you know when you're staring at an Audi. In fact, it might just be love at first sight. That's because, instead of cursing the darkness, we celebrate the light. Available full LED headlights stand out from the rest: their color inten-

sity is engineered to be reminiscent of daylight. But while we illuminate the night, we don't forget the day—so we made our LED daytime running lights to look even more dramatic. Now featuring a sleek diode design that gives us the freedom to elegantly reshape our signature style, Audi LED lighting is once again ours. It is an efficient, beautiful way to help you see and be seen from dusk to dawn and back again. Look deep into our eyes, and you might just see the soul of a company.



How we know exactly what you feel.



CLEAN, BEAUTIFUL DESIGN COMES FROM DEDICATED CRAFTSMEN UNAFRAID OF GETTING THEIR HANDS DIRTY.

Our hands give you shade and sanctuary. Our hands give you comfort and control. You might not sense our hands nearby, but our hands know exactly what you feel. That's because we've been there. After all, our hands crafted a customized world that's dedicated to control, comfort and entertainment. We're talking,

of course, about the cabin of your Audi vehicle. Optimized luxury, designed by committed craftsmen who had you in mind when they chose the leather seating surfaces, created the contoured seats or provided the refinement of ergonomic design and an available more intuitive MMI® system. There are small touches that help simplify the overall design, and there are large statements to help you feel at ease. It is your Audi interior, shaped by the kind of people who know you want to experience luxury firsthand.



As you can see, our design will help channel water away from the mirror, allowing you a clearer view of what's behind you.



The molding on the inner A-pillar helps direct water away from the area where the windshield and A-pillar meet. Once the water is there, aerodynamic forces take over and funnel the water up and out of the windshield area rather than back and across the side windows.

You have to weather adversity to know things like this.

WHAT YOU DON'T KNOW MIGHT HELP YOU.

Think of it this way—if it rains, would you notice a dry side view mirror? Maybe not, but compared to one with beads of rain on it and distorted reflections, you would. It's a little thing, perhaps, but these little things are part of our deep obsession with crafting a premium driving experience.

We design our exterior side mirrors with small sills to channel water along their upper edge, helping leave your view unobstructed. We also design our windshield moldings with channels that allow rain water to efficiently run off instead of returning to the windshield wiper path. These are small touches, thought of by engineers and crafted by designers who don't necessarily call attention to their skills. Instead, these details reflect a commitment to quality that you might never notice—until a moment of bad weather or adversity, when you might. But don't worry. We don't mind if you don't notice us, now and then.



Either think about the future, or make history.



Preproduction vehicle shown.

e-tron®



SUPREMELY PRACTICAL LUXURY WITH A SUNNY KIND OF ENERGY.

Talking about a better future is easy. After all, how can you be held accountable for something that never arrives? But if you really want to affect it, to make history, you have to do more than talk. Enter e-tron®. It's not the first plug-in electric hybrid to the market, but we are making it the most forward-thinking Audi ever produced. For

example, we will be including a level 2 charger with our A3 Sportback e-tron PHEV for qualified owners who want to drive on electricity as much as possible.¹ We also plan to offer unique sustainable energy offerings like an available solar program to help provide power to your home and vehicle. It's not just practical, it's premium too, in style, in performance and in fit and finish, like any other Audi vehicle. But more than that, it will be Audi making smart technology smarter, with adaptive kinetic-energy-harnessing when you brake, and better performing than what came before it. With the Audi e-tron vehicles, we're saying the future is now.

¹ 240-volt wall-mounted charging hardware and cabinet included with the vehicle. Installation and wiring costs are extra, and will vary. See your participating dealer for details.



The little things that add up

01 Audi connect
Our Google™ powered information system.¹

02 Audi Care
Available convenient service option.

03 MMI updates
MMI navigation and other software updates.¹

04 SiriusXM® Satellite Radio
Endlessly diverse music channels with a complimentary trial offer.¹

05 Audi exclusive
Available customizable exterior and interior color and material options.

SENSE OF HUMOR

RESOURCEFUL

ROMANTIC

SENSE OF STYLE

GENEROUS

LOVING



to a long-term love.

MOVING FROM LUST TO APPRECIATION TAKES A DEEPER UNDERSTANDING.

When you are attracted to something, the effects are immediate, the domination, total. For a relationship to last, though, it must move beyond that passionate initial phase. It's what comes next that turns a bright flame into an eternal torch. That's why Audi doesn't simply design premium vehicles for the

short-term, but offers an entire experience that we hope lasts a lifetime. Do you want to customize your Audi? We offer Audi exclusive materials and colors. Do you want care-free service options? Audi Care is available. MMI® updates, trial offers for Audi connect®, a full suite of available Audi driver assistance technologies—these might not be the reasons why you fell in love with an Audi, but they are, perhaps, the things that help keep the heart fires stoked.¹

¹ Optional features and technologies listed are not available on all models. See Infotainment/Technology section of the Featured Content page for important information regarding MMI® navigation plus and required SiriusXM® subscriptions.

YOUR FAMILY
CAN HANDLE
Q5 PUTS MORE
SOMETHING COM

Inspirations that build an icon.

The alchemy needed to build an automotive icon is elusive. Sure, it's found, partly, on an assembly line, with committed artisans taking pride in every stitch they oversee. It's also on a drafting board, sketched by visionaries looking to further expand what we look for in automotive design lines. But it's also in the countless inspirations, ones little and large, that not only capture a bold thought or striking idea, but execute them. Examples of these can be found in the foundational stories we tell about our company and our vehicles. These stories show how an abstract idea can turn into a powerful, sculpted machine, and then how that machine can help forge an iconic reputation for a brand. Out of the inspirations we find in engineering, art and the large world of ideas, we have created a fearless, iconic company of substance and luxury: Audi.

SOME
ENGINEERING
DURING THE

THE TRUTH; THE
IN YOUR DRIVE,
FORTABLE, BUT
THING DARING.
THAT UPLIFTS
PICK-UPS.



Design

We do not follow design trends. We set them.

Make this about you.

We're not saying you're the type who always needs to be the center of attention, but when you're sitting behind the wheel of the 2015 Audi Q5, that's exactly what you'll feel like. You might even say that, with this much emphasis on style, the Q5 is a magnet for looks by those who appreciate timeless design. It doesn't hurt that it boasts an unmistakable profile to complement its sporty yet sophisticated style. Or that it provides some serious fuel-saving potential, courtesy of the available Q5 hybrid or TDI® clean diesel models.^{1,2} Its interior, of course, makes for a progressive and luxurious escape from the outside world. With that said, imagine all the possibilities that the available advanced technologies on board can make real, from helping you find a new restaurant using the power of Google™ Local Search to providing almost limitless entertainment courtesy of SiriusXM® Satellite Radio, to dialing in your personal comfort. In here, you can expect to permanently steal the limelight.³



1. The Q5 hybrid is available in the U.S. in limited quantities and only at participating Audi dealers. 2. See www.fueleconomy.gov for EPA estimates. Your mileage and emissions will vary and depend on several factors, including your driving habits and vehicle condition. 3. SiriusXM Satellite Radio and SiriusXM Traffic subscriptions are sold separately or as a package after trial period and are continuous until you call SiriusXM to cancel. See Customer Agreement for complete terms and more information at www.siriusxm.com. SiriusXM Traffic service available in select markets. SiriusXM U.S. Satellite Service available only to those in the 48 contiguous U.S.A., D.C. and Puerto Rico (with coverage limitations).



Enlighten

A new light on illumination just happened to be a design boon.

You're wearing it because it works.

It's OK to boast, when it's done with some class. Take a walk around your Audi Q5, and you'll quickly realize why this vehicle isn't shy. Its striking wheels are highlighted by the elegant arc of the fenders, while the gracefully sloping roofline, accentuated by aluminum roof rails, evokes a coupe-like presence. From the front, the Singleframe® grille takes center stage with an assertive, unmistakably Audi look, while standard xenon plus headlights with signature LED daytime running lights let the masses know you worked hard to look this good.

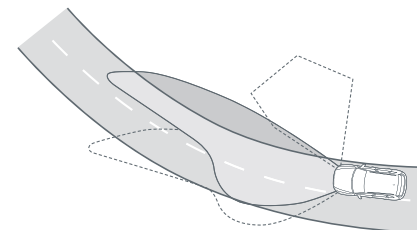

Adaptive xenon plus headlights

When driving straight, the headlights disperse light over a wide area while also casting light farther down the road on the passenger's side to help provide better long-range visibility.

Swiveling up to 15 degrees, the available adaptive xenon plus headlights direct light based on steering wheel input so that you can easily track the road ahead.

Activated when you use the turn signal, the cornering light illuminates the area to which you intend to go, giving you a well-lit path even before you initiate the turn.

It's more about losing pounds than inches.

It's surprising how many benefits are gained by shedding just a few pounds, let alone many. So it should come as no surprise, then, that we went to great lengths to reduce weight when engineering the Audi Q5. Beyond improving handling significantly, there is an even greater benefit that comes with a reduction in weight. By using aluminum in such components as the hood, tailgate, wheels and suspension, we shed a significant number of unwanted pounds, helping to diminish the load on the engine and increase overall performance. That's how we turned our loss into your gain.



Power tailgate

With a unique wraparound design that seamlessly integrates into the rear, the power tailgate on the Q5 gives you programmable end points so you can adjust the opening to the height you choose—a big help in tight spaces.

Weight-saving aluminum

Using aluminum helps reduce weight while still making for a structurally sound vehicle. And in no place is this more evident than in the all-aluminum tailgate. It weighs markedly less than a typical steel tailgate, due to its lightweight aluminum structure and wraparound design, and helps provide exceptional structural integrity.



19" alloy wheels

Adding to the already striking exterior presence are available 19" alloy wheels designed to show off the powerful stance of the Q5.





You are at the center of everything.

Look closely, and you'll notice how luxury and style have joined in perfect harmony. Consider the driver-oriented layout, where every control, gauge and switch has been placed with convenience in mind. Take another look around, and you'll also notice the high-quality materials and fine craftsmanship that envelop every square inch. From the standard Dark Brown Walnut Wood inlays to the carefully stitched leather seating surfaces, to the available three-spoke steering wheel, it all comes together to create an interior that exudes character. And when it comes time to find your favorite song or next destination, count on the available MMI[®] navigation plus to put it all right at your fingertips! This is your universe—revel in it.

Wood inlays

Speaking to the detail and craftsmanship of the Q5 are premium genuine wood inlays. They are selected, crafted and matched to the color of the dashboard and leather seating surfaces to compensate for variations in texture and reflectivity.

¹ See Infotainment/Technology section of the Featured Content page for important information regarding the MMI[®] navigation plus system.

Accommodating, no matter the position.

We don't believe versatility should impose limits on comfort. That is to say, no matter how much you reconfigure the interior of your Audi Q5, it won't impede your driving enjoyment. Available twelve-way, power-adjustable front seats give you almost unlimited options when it comes to personal comfort, while sliding and reclining rear seats make sure your passengers are included in this luxurious experience. And just try to exhaust the possible configurations afforded by the 40/20/40 split folding rear seats. We'll go out on a limb and say you can't. Let's just put it this way—you may never run out of ways to enjoy your Q5.



Adjustable rear seats

An adjustable rear bench enables the rear seats to recline 10 degrees, move forward or back 3.9" and fold completely flat, allowing for flexible cargo configurations and additional rear leg room when needed.

Twelve-way power front seats

Perfect comfort for both the driver and front passenger is just a touch of a button away with the available twelve-way power front seats.



Ventilated front seats

Available front seat ventilation offers multiple speeds of cooling, which, along with front seat-back nets and useful storage compartments in the doors, center console and cargo area, provide comfort and convenience throughout.





We can see right through you.

In here, you don't have to talk about your feelings in order to become more open. It just happens on that perfect drive, when you can feel a cool breeze as sunlight fills the cabin. That's because, in the Audi Q5, we've imagined ways to create a unique, light-filled interior that warms while it calms. We've also developed systems that help deliver personalized comfort to the driver as well as to both the front and rear passengers. And when it comes time to pick up that antique chest of drawers, you'll rest easy knowing you have plenty of cargo space to work with.



Panoramic sunroof

The available two-panel panoramic sunroof offers both the front and rear passengers an unobstructed view overhead while flooding the cabin with natural light. And when you decide you need to say goodbye to the sun, a power sunshade is there to make it an easy task.

Three-zone automatic climate control

With three distinct climate zones, the driver, front passenger and rear passengers can set their perfect level of heating or cooling with a simple twist of a dial on the center console.

Rear cargo area

Designed with the family road trip or ski vacation in mind, the Q5 doesn't hold anything back when it comes to holding your luggage. Offering 29.1 cu ft of cargo capacity with the rear seatbacks up, and up to 57.3 cu ft with the rear seatbacks folded down, there's enough room to bring just about anything you'll need. Now the only problem? Where to go next.

A gripping story of twists and turns.

The luxurious Q5 was designed with unruly roads in mind. That means, luxury aside, those gravel-strewn switchbacks and steep, graded highways are natural terrain for the quattro® all-wheel drive system. The quattro® system is designed to help provide maximum grip and optimized power delivery for practically all road conditions. So while your commute may not be as thrilling as a trip to the summit, you can be confident in the balance and enhanced performance quattro® offers day-in and day-out, while giving you no good excuse for taking a snow day.¹

quattro

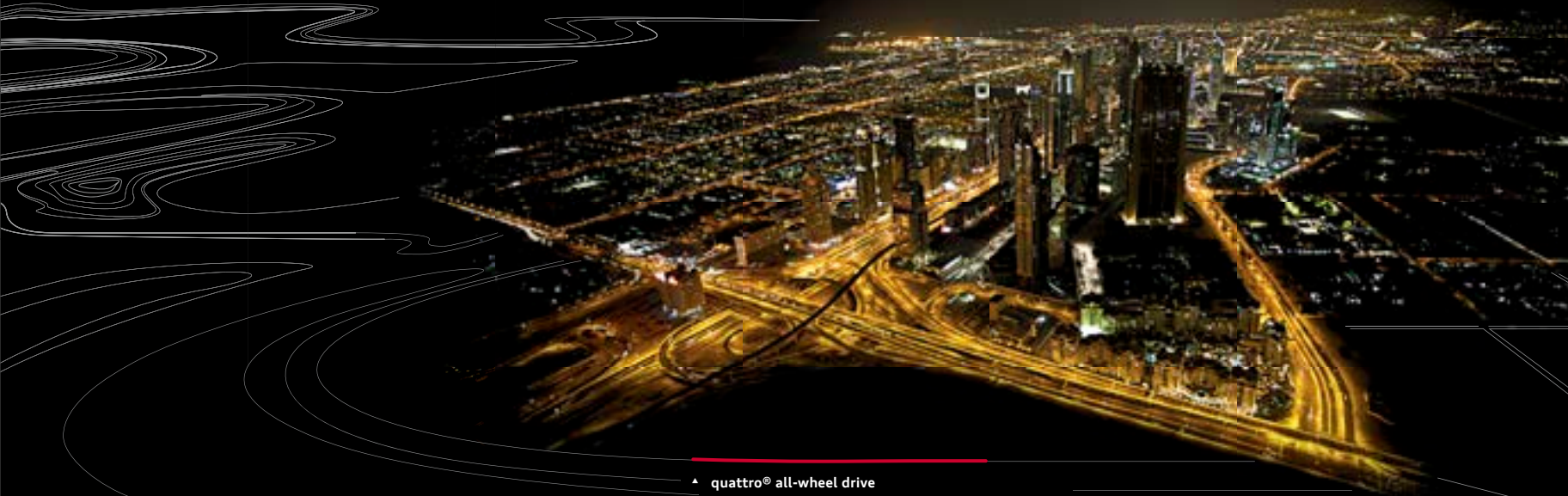

▲ quattro® all-wheel drive

With quattro®, the Q5 can “read” the road, sensing changes in the surface beneath the wheels and adjusting their grip accordingly. So when driving conditions become more demanding, quattro® adapts to deliver precisely distributed power to where it’s needed to handle the change in the terrain.

◀ All-around confidence

Just like life, the road can throw you a curve. So throw one right back with the superior grip and control of quattro® all-wheel drive. It helps provide the legendary performance and confidence you would expect from Audi, no matter if you’re commuting in the city or crisscrossing the country. This is advanced engineering you can live with.

▶ Torque vectoring

It’s a handling feature so quick that it seems to respond to your impulses instead of your steering input. An evolution of cross-axle lock, this system works within quattro®, utilizing ESC and ABS to help sense traction loss from the inside cornering tire.

▼ Seasonal stability

There is a reason quattro® all-wheel drive is a friend in foul weather.¹ Under normal driving conditions, the center differential splits torque at a ratio of 40:60, front to rear, but as conditions change and become more challenging, the ratio is optimized to help maximize grip.

¹ When driving during cold, rainy, snowy or icy weather conditions, ensure that your vehicle is equipped with appropriate all-season or winter tires. Even with appropriate tires, you must always drive in a manner appropriate for the weather, visibility and road conditions.

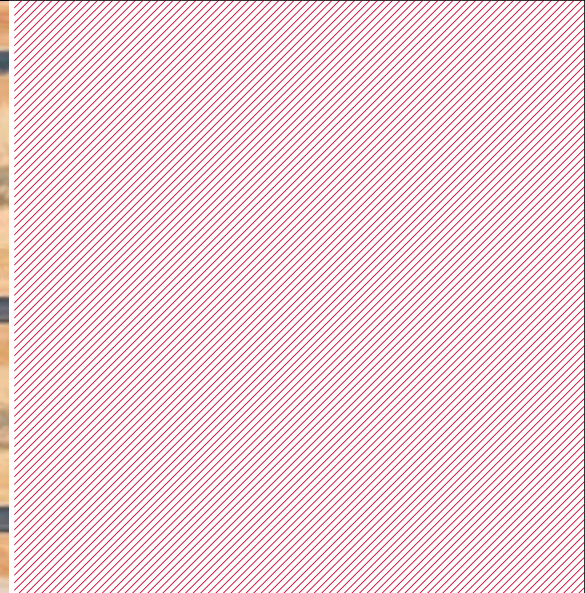
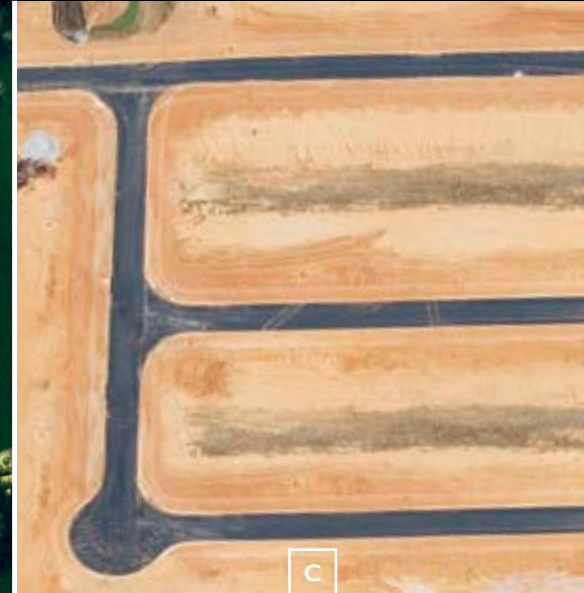

C **Comfort mode**
Perfect for those long highway stretches, this setting adds optimized suspension and steering and a closer shift pattern to help provide a more relaxed drive.

D **Dynamic mode**
Tighter steering, a firm suspension and a more responsive throttle give this setting an aggressive feel and focused performance.

A **Auto mode**
The best of both worlds, dialed to automatically adjust settings for a seamless combination of comfort and responsiveness based on your driving style and road conditions.

I **Individual mode**
Take the turn your way—this mode allows you to adjust the steering, suspension, throttle and transmission upshifts to your style.

At Audi, we believe you should be the ultimate master of your road-going domain. That's why we created the available Audi drive select system. It gives you the ability to adjust the vehicle's steering, suspension, throttle response and transmission shift characteristics with the utmost of ease. And with four modes to choose from, when almost any kind of road comes into question, Audi drive select will let you answer.

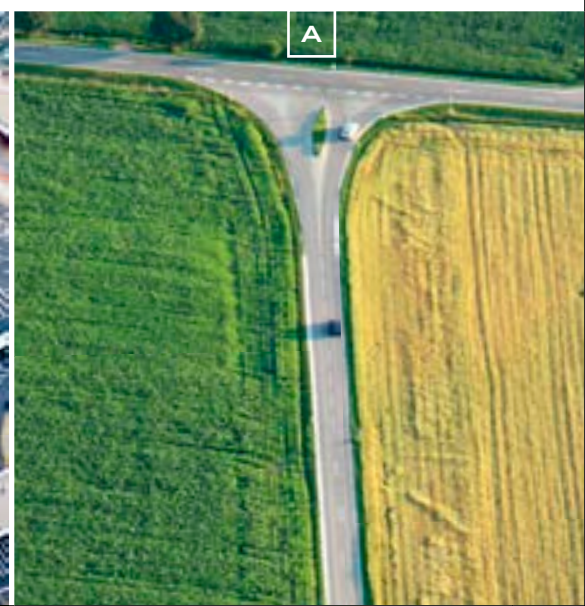
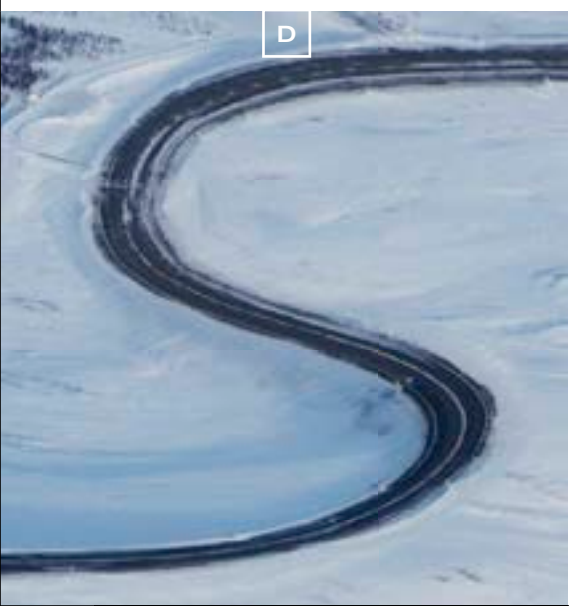

This is how power accelerates.

Consider it the beating heart of your Audi Q5. Whether you choose the acclaimed turbocharged 2.0-liter TFSI® engine that delivers impressive torque and punchy off-the-line acceleration or the supercharged 3.0-liter TFSI V6 engine that delivers potent performance due to the strong torque curve starting at low rpm, you get more beats per minute. We call that a win-win.

Induction technology—TVS supercharger

Compressing the airflow to the engine allows more air into the cylinder and, ultimately, more power from each combustion cycle, helping to improve the engine's power-to-displacement ratio.

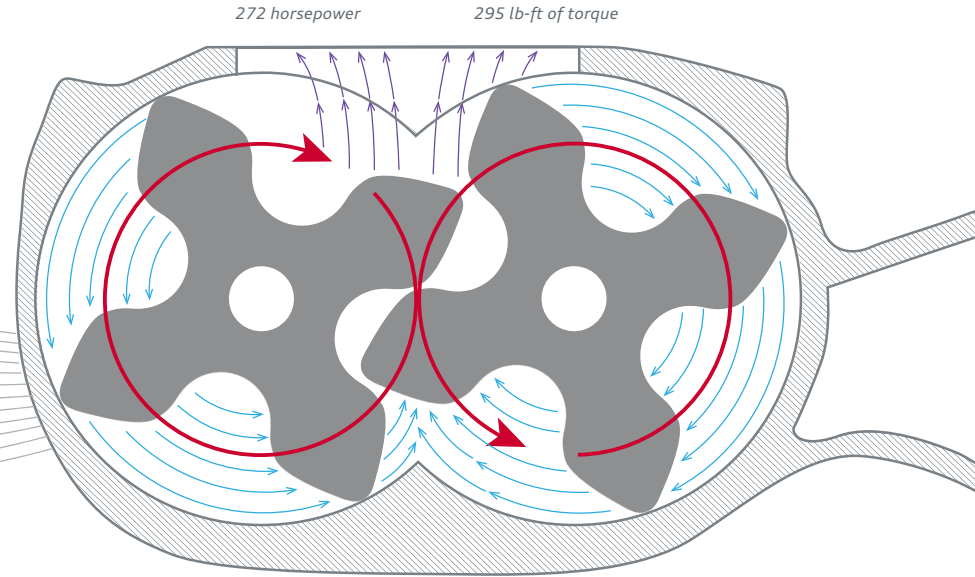
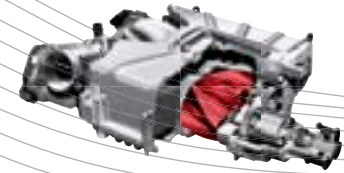

3.0 TFSI V6 supercharger illustrated above



Four-vane w/160° twist



Three-vane w/60° twist

↑ ↑

More twist for power

Modern supercharger rotor-vanes have a 160° twisted shape for higher pressures and improved efficiency. And by using a four-vane design instead of a three-vane design, thermal efficiency and air-handling characteristics are improved without increasing the size of the supercharger unit.

2.0 TFSI four-cylinder

This 2.0-liter turbocharged DOHC engine produces 220 horsepower and 258 lb-ft of torque, and combines the valvelift system, FSI® direct injection and turbocharging for great power and overall performance.

Eight-speed Tiptronic® automatic transmission

As the perfect compromise between a dedicated manual and an automatic gearbox, the eight-speed Tiptronic® automatic transmission in the Audi Q5 offers eight optimized, carefully chosen gear ratios. Selected automatically or via its console-mounted shifter or steering wheel with available shift paddles, precise shifts are delivered without sacrificing the smooth action of the Tiptronic® automatic. A high final drive ratio allows optimization of lower gears, yet the transmission's upper range emphasizes lower engine rpm—particularly at highway speeds.

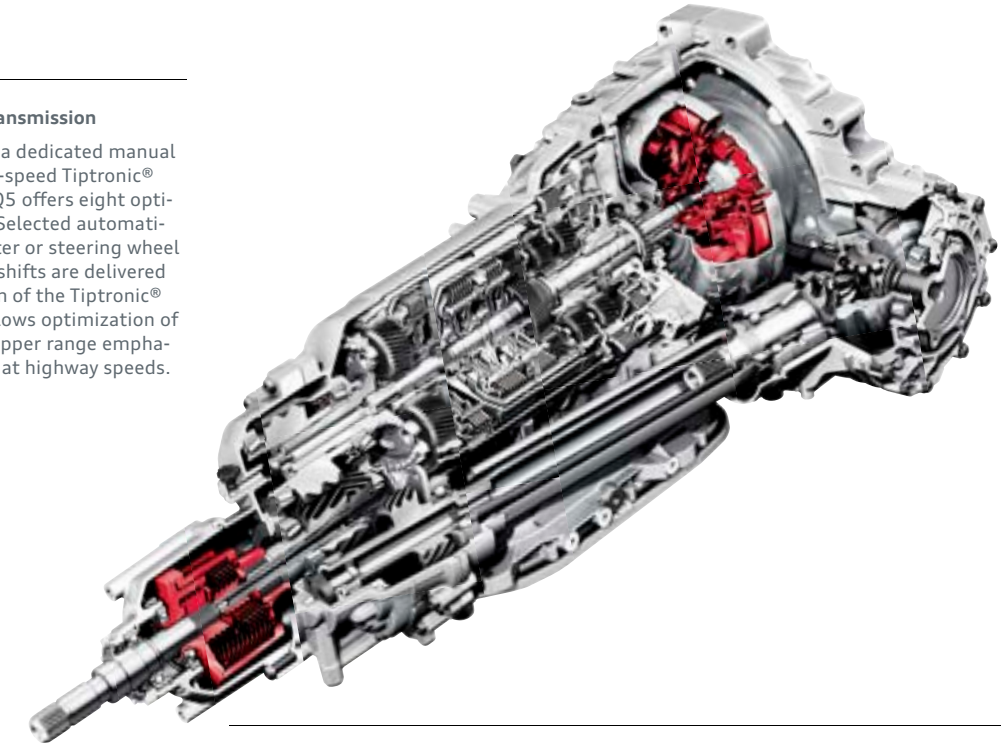

gear	ratio
1ST	4.714:1
2ND	3.143:1
3RD	2.106:1
4TH	1.667:1
5TH	1.285:1
6TH	1.000:1
7TH	0.839:1
8TH	0.667:1



Performance

The adage “good things come in small packages” has never been more true.

3.0 TFSI V6

The 272-horsepower 3.0-liter TFSI V6 engine is paired with FSI® direct injection and a belt-driven supercharger that has counter-rotating four-vane rotors that force air through dual intercoolers at boosted pressures. It is this combination of engineering achievements that allows for nearly instantaneous buildup of 295 lb-ft of torque directly off idle engine speeds.

Start-stop efficiency system

As an intelligent vehicle system, this available highly effective engine management program can lower fuel consumption as well as CO₂ emissions by automatically shutting off your engine while you wait at a red light or, perhaps, during certain stop-and-go driving. Once you are ready to resume, or if other critical vehicle systems require it, the engine will restart nearly instantaneously.¹

With efficiency comes great power.

Putting all the blame on your engine for poor acceleration is the easy way out. In many cases, the transmission is the real culprit. The Audi Q5 helps eliminate the problem with a revolutionary transmission. By utilizing optimized gear ratios, the eight-speed Tiptronic® automatic transmission is capable of transferring power in the most responsive and efficient way possible, all while allowing the driver to command upshifts or downshifts through the available steering wheel-mounted shift paddles. What you do with your newfound power is your choice.

¹ Start-stop engine efficiency system standard on 3.0T, TDI® and hybrid models.

Fuel for thought.

We thought you should know: Diesel sports a greater power density than traditional gasoline, which means that a gallon of diesel fuel has about 15% more energy than a comparable amount of gas, and combusts more efficiently in the engine. The TDI® clean diesel engine available in the Q5 has achieved ultra-low emissions vehicle (Bin-5/ULEV II) status in all 50 states while producing approximately 10.3% fewer CO₂ emissions than its comparable gasoline-fueled engine.¹ And the brainy attributes don't hide the brawn—in fact, Audi has dominated the 24 Hours of Le Mans over the years with TDI® prototype race cars. With these facts in mind, maybe you are thinking that a TDI® might be your choice—which goes to show that clean diesel really is fuel for thought.

→ → → TDI® clean diesel

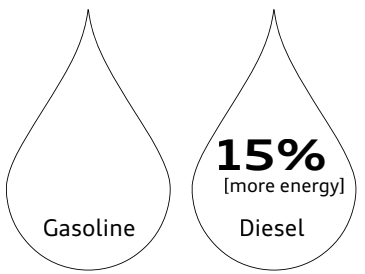

↑ ↑
Diesel packs more energy
 On average, one gallon of diesel contains about 147,000 BTUs, versus 125,000 for gasoline.



↑ ↑
Making diesel cleaner
 A new refinement process has reduced sulfur in diesel fuel by more than 97% in years past.

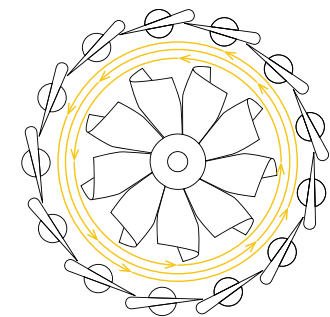

↑ ↑
Variable vane turbocharger
 Adding turbo power to clean diesel engines, our variable vane turbocharger produces impressive torque punch at mid-range highway speeds.²

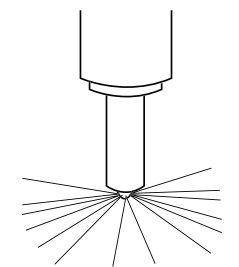

↑ ↑
Piezo direct injection
 Precise injections help lower the combustion noise normally associated with diesel engines, while optimizing the distribution of fuel in the combustion chamber, helping to further reduce exhaust emissions.

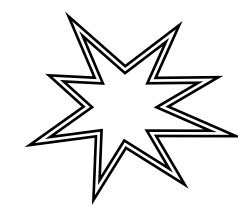

↑ ↑
Combustion
 Combining a high compression ratio with direct injection makes combustion more efficient, and produces emissions cleaner than those of engines with a lower compression ratio.

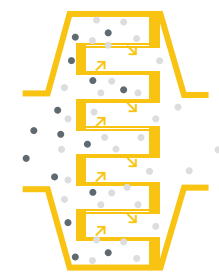

↑ ↑
After-exhaust treatment
 With innovative diesel particulate filters and the nontoxic AdBlue® reducing agent, we help eliminate up to 95% of diesel NO_x emissions.

up to
28%
 better efficiency

↑ ↑
Increased fuel efficiency
 Another way diesel creates fewer emissions is that it gets better mileage, up to 28% more mpg than comparable gasoline engines, in fact.⁵

↓ ↓ mileage	↓ ↓ range	↓ ↓ torque
24 city / 31 highway / 27 combined mpg ³	Up to 475 (city) or 613 (highway) miles per tank ⁴	428 lb-ft of torque along with 240 hp from the 3.0-liter TDI® clean diesel V6

There is more information on the TDI® clean diesel model line in the 2015 TDI® clean diesel brochure. For details, see your dealer, go to audiusa.com or download the digital brochure from the Audi library app.

1 10.3% fewer CO₂ emissions based on 2014 EPA emissions data versus its comparable gasoline-powered model. See www.fueleconomy.gov for details. Your vehicle emissions will vary and depends on several factors, including your driving habits and vehicle condition. 2 Always obey all speed and traffic laws. 3 2015 EPA estimates. Your mileage will vary and depends on several factors, including your driving habits and vehicle condition. See www.fueleconomy.gov for details. 4 24 city/31 highway mpg (2015 Q5 3.0-liter TDI® clean diesel V6 with eight-speed Tiptronic® automatic transmission and quattro® all-wheel drive). 2015 EPA estimates. Range based on EPA estimates of 24 mpg city/31 mpg highway and a 19.8-gallon fuel tank. Your mileage will vary and depends on several factors, including your driving habits and vehicle condition. 5 28% better mileage over comparable gasoline engines is based on 2015 Q5 TDI® model's 27 combined mpg as rated by the EPA vs. the 2014 EPA-rated gasoline-powered equivalent. Your mileage will vary and depends on several factors, including your driving habits and vehicle condition.

When it comes to hybrid, you may need to think outside the box.

The word *hybrid* has a different meaning around here. To us, it means twenty-first century performance. The relentless torque of an electric motor combined with the big horsepower of a combustion engine. But the Audi Q5 hybrid also proves that being efficient doesn't have to be a drag on straight-line thrills.^{1,2,3} By coupling the legendary Audi 2.0-liter TFSI® engine with a 54-hp electric motor, the total combined system output jumps to 245 hp, ensuring that the Q5 hybrid lives up to the strict performance standards of Audi, leaving other luxury crossovers stinging with jealousy. Of course, this being an Audi, you'll be forgiven for not thinking about how efficiently you're getting from place to place, as you're wrapped in exquisite luxury.¹ It's time to send your old notions of a hybrid to a better place.



Hybrid exterior appearance

Setting the Q5 hybrid apart from its siblings are subtle, stylized visual effects. Hybrid badges grace the rear hatch, fenders and door sills, while the signature Singleframe® grille features a custom high-gloss black finish. Hybrid-specific 19" wheels round out its elegant look.

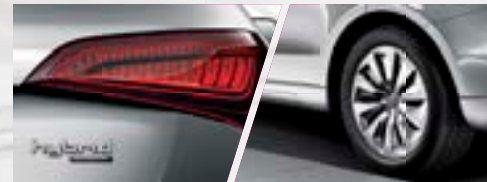

Exclusive 19" 10-arm-turbine design wheels

2.0 TFSI with quattro®

Even without the aid of the electric motor, the Audi 2.0-liter TFSI engine is one formidable player. Add in the legendary handling of quattro® all-wheel drive, and the Q5 hybrid provides as much poise as it does performance.

Power

245 hp/350 lb-ft of torque

↓ ↓

↑ ↑
6.8 seconds

↑ ↑
0-60 mph



Lithium-ion battery system

The advanced lithium-ion battery used in the Q5 hybrid serves as the energy storage unit for the electric motor. Its large energy reserves, combined with the high-output 54-hp electric motor, allow for full electric driving at speeds of up to 62 mph.

Power

266 volts/1.3 kWh energy

battery weight 81 lb



Power meter

Taking the place of the tachometer, the power meter displays the hybrid system's total power output, providing efficiency information in real time.

¹ 24 city/30 highway/26 combined mpg (2015 Q5 hybrid with eight-speed Tiptronic® automatic transmission and quattro® all-wheel drive). 2015 EPA estimates. Your mileage will vary and depends on several factors, including your driving habits and vehicle condition.
² The Q5 hybrid is available in the U.S. in limited quantities and only at participating Audi dealers. ³ Always obey all speed and traffic laws.

A little insight into the things you cannot see.

Audi strives to constantly up the ante on the driver assistance tools built right into the vehicle. Evidence for this can be found in the available Audi side assist, which helps inform you if there are vehicles in the lanes next to you. Or in the available Audi adaptive cruise control, which helps monitor the distance between you and the vehicle ahead of you and adjusts your speed appropriately. You can also see it in something as simple as parking system plus, which adds a rear view camera and front/rear acoustic parking sensors. All of these show the effort we put into helping ensure that you're not the only one keeping an eye on the road.



Driver Assistance

We're solving problems before you even know you have them.

Audi adaptive cruise control

Everyone has their own comfort zone. The available Audi adaptive cruise control helps maintain a driver-selected distance from the vehicle in front by using a special long-range radar sensor. The system constantly measures the space between your vehicle and the vehicle ahead and helps manage it by automatically adjusting your speed. Once the road ahead is clear, the vehicle effortlessly resumes the previously preset speed, helping to make your drive that much more relaxing.¹

Audi side assist

The available Audi side assist uses radar sensors and two different optical warnings to help keep the driver informed about what is approaching from hard-to-see angles behind and to the side of the vehicle.



¹ Audi adaptive cruise control not available on Q5 hybrid Prestige models.

A little give requires a lot of strength.

We decided that, regardless of size, strong should be a more flexible concept. High-strength steel helps add a measure of security while enhancing overall handling and performance. The six standard airbags¹ feature technology that is designed to deploy airbags based on seat position, while specially constructed crumple zones give way upon impact to help mitigate potential injury in a collision. All of this, combined with the rigidity of laser seam-welded joints that enhance the strength of every Audi we make, helps diminish the impact of an unavoidable event.



Dramatization²

Six standard airbags

With six standard airbags, including front-impact and thorax side airbags for both driver and front passenger, and available rear-passenger thorax side airbags, you'll feel practically surrounded.¹ And that's a good thing.



Safety

Working to spread a "bend, don't break" philosophy.

ESC and ABS

Whether you're on the open road or off the beaten path, ESC with ABS helps to keep the vehicle traveling in its intended direction by moderating brake pressure at all four wheels to help maintain traction, minimize skids and optimize control.

¹ Airbags are supplemental restraints only and will not deploy in all crash circumstances. Always use safety belts and seat children only in the rear, using restraint systems appropriate for their size and age. ² This is a dramatization and does not depict what will happen in a collision. All bags will not inflate simultaneously in real-world collisions, and, if multiple bags do deploy, they will be in various stages of inflating/deflating and will never all be inflated at the same time.

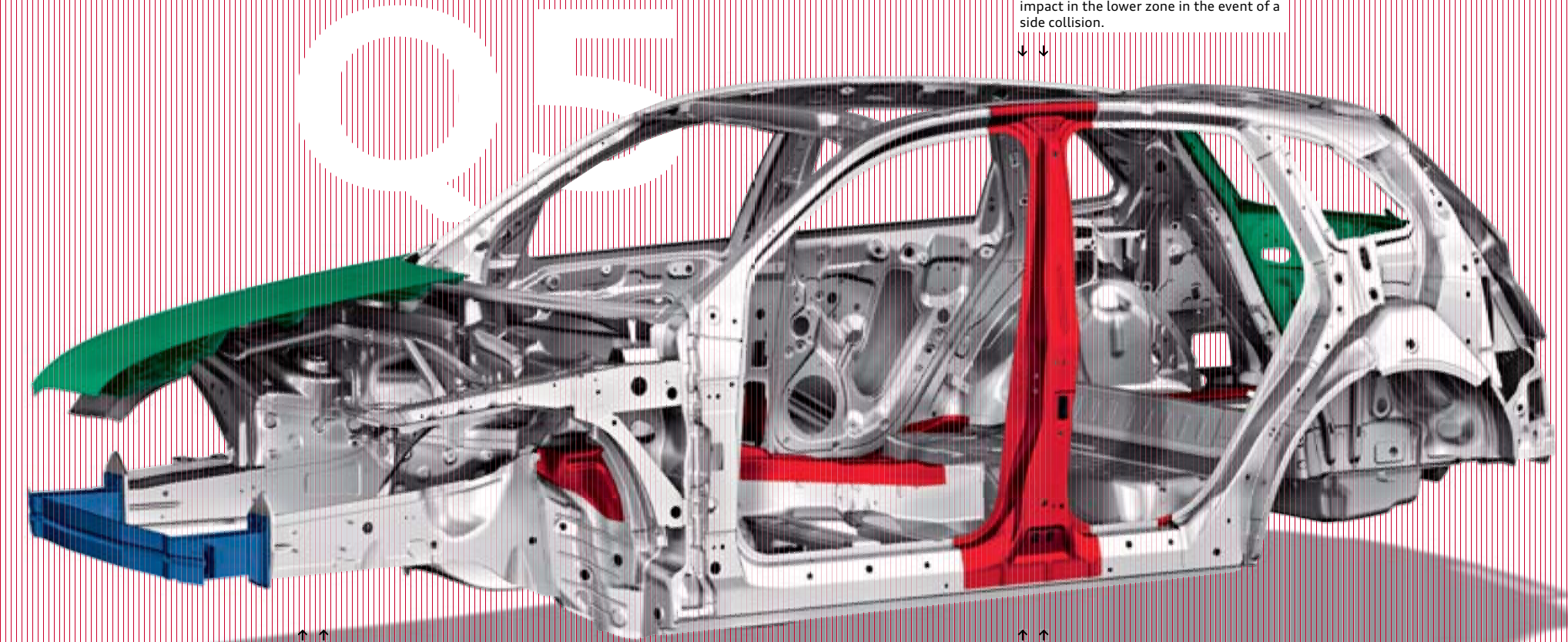

Tailor-made blanks

Developed to make the best possible use of the body's potential, tailor-made blanks are the result of a special manufacturing process that can help strengthen the upper zone of a B-pillar while mitigating the impact in the lower zone in the event of a side collision.



Crumple zones

Knautschzone may be an ugly word, but it's a beautiful technology. German for "crumple zone," this ingenious feature helps dissipate the energy from a collision by spreading the impact forces around the passenger cell and away from its occupants. In doing so, it also slows the vehicle's deceleration rate, which helps to further lessen the force of impact.

High-strength steel

High-strength steel in the chassis rail side-member and B-pillars helps protect the driver and passengers in the event of a collision.

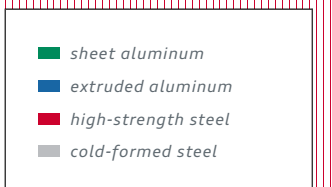

Get in touch with your inner techie.

We believe intelligence is key to a higher form of luxury. You can see this philosophy fully represented in the available MMI® system. Simply put, it's an intuitive system that intimately connects you to almost every facet of the vehicle. It's the nerve center of your vehicle, allowing you to control virtually every interior function of your Audi with a simplified source control button system. Whether it's MMI navigation plus, or BLUETOOTH® streaming audio, MMI helps you access information with a few easy clicks. And even without it, you can pair your compatible phone with the vehicle for added convenience. With this kind of brainpower onboard, you can leave the little stuff to us, and just concentrate on how good it feels to drive.^{1,2}



MMI System

Putting your needs front and center.

SiriusXM® Satellite Radio

Go ahead. Crisscross the country. We assure you, you'll never run out of entertainment options, with over 150 channels of music, talk, sports and news.¹

Audi media

The media function opens up a world of options when equipped with the MMI navigation plus, allowing you to control the Audi music interface, Secure Digital (SD) card slots, hard disk drive (HDD) audio jukebox or DVD, and BLUETOOTH® streaming audio from a compatible device.^{1,2}

MMI navigation plus

Count on the available advanced navigation system to home in on your destination with stunning precision while putting a little more depth in your journey with help from the available Audi connect^{®1,2}

BLUETOOTH® wireless technology

Unlock your compatible mobile phone's potential through the MMI system. Simply pair them up and start enjoying near complete control at the touch of a button.

¹ See Infotainment/Technology section of the Featured Content page for important information regarding MMI® navigation plus and required SiriusXM® subscriptions. ² Always pay careful attention to the road, and do not drive while distracted. The features and technologies discussed above are optional, may require an additional subscription with separate terms and conditions, and should be used only when it is safe and appropriate. The Wi-Fi® hotspot feature is intended for passenger use only.



Tell us what you're looking for and we'll deliver you to it.

Don't reach—relax. While touchscreens are seemingly everywhere, they don't need to be in your vehicle. With available Audi connect®, you may never have to reach out again.¹ Thanks to Google Voice™ Local Search, Audi connect allows you to quickly search Google™ by simple voice commands (use only when the car is stationary).¹ The crisp display is mounted farther up, closer to the windshield and near your sight line to the road ahead. For those times when you are feeling tactile, we've placed toggle buttons near the gear shifter, where your hand naturally rests when using them. So while other automobile manufacturers still want you to reach out, we've found a few ways for you to make information a lot more accessible while your hands are on the wheel.¹

POI

Point-of-interest

The point-of-interest search with voice control means that the digital world is with you on every journey.¹

myAudi

myAudi features

Plan travel from your personal computer. Send your desired destinations to your vehicle ahead of time and access your route from your vehicle later.¹

NEWS

News feeds

Stay on top of the news by having headlines and stories delivered right to your MMI® display.¹

Mobile Wi-Fi® hotspot

Mobile Wi-Fi® hotspot

Provides high-speed connectivity for up to eight passenger devices through an onboard wireless hub.¹



SiriusXM® Traffic

Get traffic information overlaid onto available 3D satellite imagery to visualize a true aerial view of your route, and let the MMI navigation plus system reconfigure your route to help avoid traffic.^{1,2}



Google Earth™ with 3D satellite imagery

With Google Earth™ integration, you'll enjoy 3D satellite imagery, including Google Maps Street View, displayed right on the MMI display.¹



Weather information

Current local conditions and forecasts for your destination can help you prepare for your trip.¹



Google Voice™ Local Search

Simply tell your Audi what you are in the mood for, then let the cloud-processing power of Google™ speech recognition interpret your request and bring up a list of destinations in the area of your choice.¹



Google Maps Street View

With Google Maps Street View, your vehicle can show you a driver's-eye view of your destination right before you arrive so it's easy to recognize.¹



Parking information

Search for parking in your area of interest, check space availability and set your selection as a destination to help navigate directly to the garage entrance.^{1,3}



City events

Get information about current events, exciting locations and places of interest at your travel destination, current location or other chosen location instantly.¹



Travel info

Discover local landmarks in your area of interest, set them as your destinations, and let your vehicle lead the way as you explore the world around you.¹

¹ Always pay careful attention to the road, and do not drive while distracted. The features and technologies discussed above are optional, may require an additional subscription with separate terms and conditions, and should be used only when it is safe and appropriate. The Wi-Fi® hotspot feature is intended for passenger use only. ² See Infotainment/Technology section of the Featured Content page for important information regarding MMI® navigation plus and required SiriusXM® subscriptions. ³ Parking information is not available everywhere and requires participation by parking provider.



Sound

Audi is Latin for "listen," so you know we take sound very seriously.

52 Hz

Low note on a kick drum

True bass tones are something you feel more than hear, and when a kick drum hits you with a frequency of 52 Hz, you definitely feel it. Knowing this, Audi sound engineers worked to reproduce sounds at this level for an exceptionally realistic experience.

2,093 Hz

High note on a piano

Even at a frequency of 2,093 Hz, the equivalent of the double high C note found on a piano, the sound system clearly and effortlessly reproduces the sound, giving you front row seats to every symphony.

261 Hz

Singing middle C

At a frequency of around 261 Hz, you'll find middle C. It is around this frequency that much of the brilliantly orchestrated sound is reproduced by the numerous, strategically placed speakers.

Lend us your ear.

It's been said that people only hear what they want to. That what they don't like just goes in one ear and out the other. Well, for those people and everyone else, we've created a sound system that makes every note worthy of your eardrum's full attention. From perfectly sculpted high notes to a crystal clear mid-range to deep-diving lows, the available Bang & Olufsen® Sound System is a veritable orchestra of engineering that fills the cabin with faithfully rendered, thrilling sound. Which shouldn't be surprising at all, considering that Bang & Olufsen® and Audi sound engineers worked tirelessly to craft a perfect acoustic environment, and the ideal delivery system for it. So whether you're the type that wants to be soothed by sound or the type that wants to be inspired by it, we promise, if you take a moment to listen, that what you'll hear will be utterly impossible to ignore.



Bang & Olufsen® Sound System

Dedicated to the idea of "honest music reproduction," Bang & Olufsen® is a sound engineer's dream. Through an available 505-watt, 14-speaker system perfectly integrated within your Audi, Bang & Olufsen® is set on transcending the limits of audio technology. By automatically adjusting volume and timbre balance to changing ambient noise levels and offering richly tuned acoustics, you'll hear the truth about how good life can sound in your Audi.

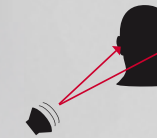

Unlike with high-frequency sounds, the brain cannot detect where low bass frequencies are coming from, making it seem as if the sound is hitting both ears at the same time. Because of this, Bang & Olufsen® sound engineers only had to design one custom-fitted subwoofer to reproduce the kind of deep, cabin-filling bass that brings music to life.



SQ5

ENGINE // 3.0-liter supercharged TFSI® V6 developing 354 hp and 346 lb-ft of torque

DRIVETRAIN // quattro® all-wheel drive, eight-speed Tiptronic® automatic transmission

CHASSIS // SQ5 tuned sport suspension calibration, Audi drive select and available dynamic steering

BRAKES // 15.0" ventilated front disc brakes with S logo, 13.0" ventilated rear disc brakes

PERFORMANCE // Top track speed of 155 mph,¹ acceleration from 0 to 60 mph in 5.1 seconds

¹ Top track speed is electronically limited in the U.S. Always obey all speed and traffic laws.



We drew the line prior to crossing it.

There's a way to tell people, "I'm in a league of my own," and still come off as modest. Introducing the all-new Audi SQ5. It's bursting at the seams with performance numbers—354-hp TFSI® V6 engine, 346 lb-ft of torque, 0 to 60 mph in 5.1 seconds—but its sport stance and flared fenders will turn heads, even at a standstill. Add to that our signature LED taillights—standard on all Q5 models—as brilliant as they are unmistakably Audi, and a pair of beautifully sculpted quad exhaust outlets perfectly integrated into the lower bumper. It's our answer to the more reserved CUV.

Audi Sport
Truth in Engineering



The story doesn't stop here. There's more on the full range of S, RS, and R8 Audi performance models in the **2015 Audi Sport brochure**. See your dealer or go to audiusa.com for details.

2.0T Premium

Q5 2.0T Premium featured highlights

- ▶ Singleframe® grille
- ▶ Xenon plus headlights with LED daytime running lights
- ▶ Front and rear fog lights
- ▶ LED taillights
- ▶ Power-adjustable heated exterior side mirrors
- ▶ LED turn indicator lights integrated into the exterior side mirrors
- ▶ Heated windshield washer nozzles
- ▶ Aluminum roof rails
- ▶ Aluminum trim around exterior windows
- ▶ Power tailgate
- ▶ Flat-bottom dual exhaust outlets with polished tips
- ▶ Three-zone automatic climate control
- ▶ Four-spoke multifunction steering wheel
- ▶ Tilt and telescopic manually adjustable steering column
- ▶ Leather-wrapped shift knob
- ▶ Folding and sliding front center armrest with height adjustment
- ▶ Ambient LED interior lighting
- ▶ Power windows with one-touch up/down operation and pinch protection
- ▶ Rear cargo cover, tilts when tailgate is opened
- ▶ Leather seating surfaces
- ▶ Eight-way power front seats and four-way power lumbar adjustment for driver
- ▶ Sliding 40/20/40 split folding rear seat with pass-through and adjustable recline
- ▶ Driver information system
- ▶ Audi concert radio with ten speakers and single CD player with MP3 playback capability
- ▶ SiriusXM® Satellite Radio with 90-day trial subscription¹
- ▶ SD card slot with 32GB operating capacity (dual slots if equipped with MMI® navigation plus)
- ▶ Audi music interface with iPod® integration
- ▶ BLUETOOTH® wireless technology preparation for mobile phone²
- ▶ Four 12-volt power outlets
- ▶ Garage door opener (HomeLink®)
- ▶ Cruise control with coast, resume and accelerate features

Available packages and stand-alone options

(for more details, refer to the Packages and Options pages)

- ▶ Navigation plus package
- ▶ 19" 5-arm-star design wheels
- ▶ Rear-passenger thorax side airbags³
- ▶ Heated front seats
- ▶ Panoramic sunroof
- ▶ Aluminum Satellite decorative inlays
- ▶ Fine Grain Ash Natural Brown Wood decorative inlays



Power tailgate



Xenon plus headlights with LED daytime running lights

LED taillights



Dark Brown Walnut Wood decorative inlays



18" 5-spoke V design wheels with 235/60 all-season tires



Three-zone automatic climate control

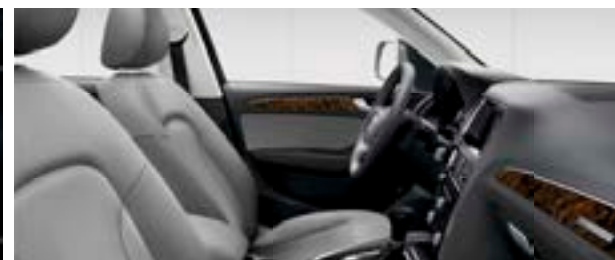

Standard leather seating surfaces



Aluminum roof rails



Garage door opener (HomeLink®)



¹ SiriusXM Satellite Radio and SiriusXM Traffic subscriptions are sold separately or as a package after trial period and are continuous until you call SiriusXM to cancel. See Customer Agreement for complete terms and more information at www.siriusxm.com. SiriusXM Traffic service available in select markets. SiriusXM U.S. Satellite Service available only to those in the 48 contiguous U.S.A., D.C. and Puerto Rico (with coverage limitations). ² Requires compatible device. ³ Airbags are supplemental restraints only and will not deploy in all crash circumstances. Always use safety belts and seat children only in the rear, using restraint systems appropriate for their size and age.

2.0T Premium Plus

The following highlighted features of the Q5 2.0T Premium Plus add to or replace the highlighted features of the Q5 2.0T Premium

- ▶ Power-adjustable, power-folding, auto-dimming, heated exterior side mirrors with memory
- ▶ Auto-dimming interior rear view mirror with digital compass
- ▶ Stainless steel door sill inlays
- ▶ Panoramic sunroof
- ▶ Driver seat memory
- ▶ Heated front seats
- ▶ Audi advanced key—keyless start, stop and entry¹

Available packages and stand-alone options

(for more details, refer to the Packages and Options pages)

- ▶ Technology package
- ▶ Sport Interior package
- ▶ 19" 5-arm-star design wheels
- ▶ Bang & Olufsen® Sound System with 14 speakers and 505 watts
- ▶ Rear-passenger thorax side airbags²
- ▶ Panoramic sunroof deletion
- ▶ Aluminum Satellite decorative inlays
- ▶ Fine Grain Ash Natural Brown Wood decorative inlays



Panoramic sunroof with power sunshade



Driver seat memory



Heated front seats



Dark Brown Walnut Wood decorative inlays



18" 5-spoke V design wheels with 235/60 all-season tires



Audi advanced key—keyless start, stop and entry¹



Power-adjustable, power-folding, auto-dimming, heated exterior side mirrors with memory



Auto-dimming interior rear view mirror with digital compass



¹ Some Audi models are equipped with a keyless ignition feature. The details as to how the system works can vary, and Audi owners should consult their owner's literature or an authorized Audi dealer if they have further questions about the operation of this feature. Please note that Audi warns against leaving the vehicle unattended with the engine running, particularly in enclosed spaces. ² Airbags are supplemental restraints only and will not deploy in all crash circumstances. Always use safety belts and seat children only in the rear, using restraint systems appropriate for their size and age.

3.0T Premium Plus

The following highlighted features of the Q5 3.0T Premium Plus add to or replace the highlighted features of the Q5 2.0T Premium

- ▶ Headlight washing system
- ▶ S line® exterior appearance
- ▶ Auto-dimming interior rear view mirror with digital compass
- ▶ Stainless steel door sill inlays
- ▶ Panoramic sunroof
- ▶ Three-spoke multifunction steering wheel
- ▶ Driver seat memory
- ▶ Heated front seats
- ▶ Audi advanced key—keyless start, stop and entry¹

Available packages and stand-alone options
(for more details, refer to the Packages and Options pages)

- ▶ Sport Interior package
- ▶ High-gloss Black package
- ▶ Luxury package
- ▶ Technology package
- ▶ Bang & Olufsen® Sound System with 14 speakers and 505 watts
- ▶ Rear-passenger thorax side airbags²
- ▶ Panoramic sunroof deletion
- ▶ Aluminum Satellite decorative inlays
- ▶ Fine Grain Ash Natural Brown Wood decorative inlays
- ▶ 20" 5-arm design wheels



S line® exterior appearance



Driver seat memory



Heated front seats



Dark Brown Walnut Wood decorative inlays



19" 5-arm star design wheels with 235/55 all-season tires



Audi advanced key—keyless start, stop and entry¹



Three-spoke multifunction steering wheel



Panoramic sunroof with power sunshade



Auto-dimming interior rear view mirror with digital compass



¹ Some Audi models are equipped with a keyless ignition feature. The details as to how the system works can vary, and Audi owners should consult their owner's literature or an authorized Audi dealer if they have further questions about the operation of this feature. Please note that Audi warns against leaving the vehicle unattended with the engine running, particularly in enclosed spaces. ² Airbags are supplemental restraints only and will not deploy in all crash circumstances. Always use safety belts and seat children only in the rear, using restraint systems appropriate for their size and age.

3.0T Prestige

The following highlighted features of the Q5 3.0T Prestige add to or replace the highlighted features of the Q5 3.0T Premium Plus

- ▶ Adaptive xenon plus headlights with LED daytime running lights
- ▶ Thermo cup holder
- ▶ Manual rear-side sunshades
- ▶ MMI® navigation plus with voice control system¹
- ▶ Audi connect® with six-month trial subscription²
- ▶ Color driver information system
- ▶ Bang & Olufsen Sound System with 14 speakers and 505 watts
- ▶ HD Radio™ Technology
- ▶ SiriusXM® Traffic with four-year subscription³
- ▶ BLUETOOTH® streaming audio⁴
- ▶ Audi side assist
- ▶ Parking system plus with rear view camera (front and rear acoustic parking sensors)

Available packages and stand-alone options

(for more details, refer to the Packages and Options pages)

- ▶ Sport Interior package
- ▶ High-gloss Black package
- ▶ Luxury package
- ▶ Audi exclusive line package
- ▶ Driver Assistance package
- ▶ Rear-passenger thorax side airbags⁵
- ▶ Panoramic sunroof deletion
- ▶ Aluminum Satellite decorative inlays
- ▶ Fine Grain Ash Natural Brown Wood decorative inlays
- ▶ Adaptive damping suspension
- ▶ 20" 5-arm design wheels



MMI® navigation plus with voice control system and Audi connect® online services



Parking system plus with front and rear acoustic parking sensors Parking system plus with rear view camera parking sensors



Dark Brown Walnut Wood decorative inlays



19" 5-arm star design wheels with 235/55 all-season tires



Adaptive xenon plus headlights with LED daytime running lights



Bang and Olufsen® Sound System



Thermo cup holder



Audi side assist



¹ MMI® navigation plus depends on signals from the worldwide Global Positioning Satellite network. The vehicle's electrical system and existing wireless and satellite technologies must be available and operating properly for the system to function. The system is designed to provide you with suggested routes in locating addresses, destinations and other points of interest. Changes in street names, construction zones, traffic flow, points of interest and other road system changes are beyond the control of Audi of America, Inc. Complete detailed mapping of lanes, roads, streets, toll roads, highways, etc., is not possible, therefore you may encounter discrepancies between the mapping and your actual location. Please rely on your individual judgment in determining whether or not to follow a suggested MMI® navigation plus route. For mapping updates please see your Audi dealer or call 1-800-FOR-AUDI for details. ² Always pay careful attention to the road, and do not drive while distracted. The features and technologies discussed above are optional, may require an additional subscription with separate terms and conditions, and should be used only when it is safe and appropriate. The Wi-Fi® hotspot feature is intended for passenger use only. ³ SiriusXM Satellite Radio and SiriusXM Traffic subscriptions are sold separately or as a package after trial period and are continuous until you call SiriusXM to cancel. See Customer Agreement for complete terms and more information at www.siriusxm.com. SiriusXM Traffic service available in select markets. SiriusXM U.S. Satellite Service available only to those in the 48 contiguous U.S.A., D.C. and Puerto Rico (with coverage limitations). ⁴ Requires compatible device. ⁵ Airbags are supplemental restraints only and will not deploy in all crash circumstances. Always use safety belts and seat children only in the rear, using restraint systems appropriate for their size and age.

TDI® Premium Plus

The following highlighted features of the Q5 TDI® Premium Plus add to or replace the highlighted features of the Q5 2.0T Premium

- ▶ Power-adjustable, power-folding, auto-dimming, heated exterior side mirrors with memory
- ▶ Auto-dimming interior rear view mirror with digital compass
- ▶ Stainless steel door sill inlays
- ▶ Panoramic sunroof
- ▶ Three-spoke multifunction steering wheel
- ▶ Driver seat memory
- ▶ Heated front seats
- ▶ Audi advanced key—keyless start, stop and entry¹

Available packages and stand-alone options
(for more details, refer to the Packages and Options pages)

- ▶ Sport Interior package
- ▶ S line® plus package
- ▶ Luxury package
- ▶ Technology package
- ▶ Bang & Olufsen® Sound System with 14 speakers and 505 watts
- ▶ Rear-passenger thorax side airbags²
- ▶ Panoramic sunroof deletion
- ▶ Aluminum Satellite decorative inlays
- ▶ Fine Grain Ash Natural Brown Wood decorative inlays
- ▶ 20" 5-arm design wheels



Panoramic sunroof with power sunshade



Driver seat memory



Heated front seats



Dark Brown Walnut Wood decorative inlays



19" 5-arm star design wheels with 235/55 all-season tires



Audi advanced key—keyless start, stop and entry¹



Three-spoke multifunction steering wheel



Power-adjustable, power-folding, auto-dimming, heated exterior side mirrors with memory



Auto-dimming interior rear view mirror with digital compass



¹ Some Audi models are equipped with a keyless ignition feature. The details as to how the system works can vary, and Audi owners should consult their owner's literature or an authorized Audi dealer if they have further questions about the operation of this feature. Please note that Audi warns against leaving the vehicle unattended with the engine running, particularly in enclosed spaces. ² Airbags are supplemental restraints only and will not deploy in all crash circumstances. Always use safety belts and seat children only in the rear, using restraint systems appropriate for their size and age.

TDI® Prestige

The following highlighted features of the Q5 TDI® Prestige add to or replace the highlighted features of the Q5 TDI® Premium Plus

- ▶ Adaptive xenon plus headlights with LED daytime running lights
- ▶ Thermo cup holder
- ▶ Manual rear-side sunshades
- ▶ MMI® navigation plus with voice control system¹
- ▶ Audi connect® with six-month trial subscription²
- ▶ Color driver information system
- ▶ Bang & Olufsen® Sound System with 14 speakers and 505 watts
- ▶ HD Radio™ Technology
- ▶ SiriusXM® Traffic with four-year subscription³
- ▶ BLUETOOTH® streaming audio⁴
- ▶ Audi side assist
- ▶ Parking system plus with rear view camera (front and rear acoustic parking sensors)

Available packages and stand-alone options

(for more details, refer to the Packages and Options pages)

- ▶ Sport Interior package
- ▶ S line® plus package
- ▶ Luxury package
- ▶ Audi exclusive line package
- ▶ Driver Assistance package
- ▶ Rear-passenger thorax side airbags⁵
- ▶ Panoramic sunroof deletion
- ▶ Aluminum Satellite decorative inlays
- ▶ Fine Grain Ash Natural Brown Wood decorative inlays
- ▶ Adaptive damping suspension
- ▶ 20" 5-arm design wheels



MMI® navigation plus with voice control system and Audi connect® online services



Parking system plus with front and rear acoustic parking sensors Parking system plus with rear view camera parking sensors



Dark Brown Walnut Wood decorative inlays



19" 5-arm star design wheels with 235/55 all-season tires



Adaptive xenon plus headlights with LED daytime running lights



Bang and Olufsen® Sound System



Thermo cup holder



Audi side assist



¹ MMI® navigation plus depends on signals from the worldwide Global Positioning Satellite network. The vehicle's electrical system and existing wireless and satellite technologies must be available and operating properly for the system to function. The system is designed to provide you with suggested routes in locating addresses, destinations and other points of interest. Changes in street names, construction zones, traffic flow, points of interest and other road system changes are beyond the control of Audi of America, Inc. Complete detailed mapping of lanes, roads, streets, toll roads, highways, etc., is not possible, therefore you may encounter discrepancies between the mapping and your actual location. Please rely on your individual judgment in determining whether or not to follow a suggested MMI® navigation plus route. For mapping updates please see your Audi dealer or call 1-800-FOR-AUDI for details. ² Always pay careful attention to the road, and do not drive while distracted. The features and technologies discussed above are optional, may require an additional subscription with separate terms and conditions, and should be used only when it is safe and appropriate. The Wi-Fi® hotspot feature is intended for passenger use only. ³ SiriusXM Satellite Radio and SiriusXM Traffic subscriptions are sold separately or as a package after trial period and are continuous until you call SiriusXM to cancel. See Customer Agreement for complete terms and more information at www.siriusxm.com. SiriusXM Traffic service available in select markets. SiriusXM U.S. Satellite Service available only to those in the 48 contiguous U.S.A., D.C. and Puerto Rico (with coverage limitations). ⁴ Requires compatible device. ⁵ Airbags are supplemental restraints only and will not deploy in all crash circumstances. Always use safety belts and seat children only in the rear, using restraint systems appropriate for their size and age.

hybrid Prestige

The following highlighted features of the Q5 hybrid Prestige add to or replace the highlighted features of the Q5 2.0T Premium Plus

- ▶ Adaptive xenon plus headlights with LED daytime running lights
- ▶ Thermo cup holder
- ▶ Manual rear-side sunshades
- ▶ Three-spoke multifunction steering wheel
- ▶ MMI® navigation plus with voice control system¹
- ▶ Audi connect® with six-month trial subscription²
- ▶ Color driver information system
- ▶ Bang & Olufsen® Sound System with 14 speakers and 505 watts
- ▶ HD Radio™ Technology
- ▶ SiriusXM® Traffic with four-year subscription³
- ▶ BLUETOOTH® streaming audio⁴
- ▶ Audi side assist
- ▶ Parking system plus with rear view camera (front and rear acoustic parking sensors)

Available packages and stand-alone options
(for more details, refer to the Packages and Options pages)

- ▶ Luxury package
- ▶ Sport Interior package
- ▶ Audi exclusive line package
- ▶ Rear-passenger thorax side airbags⁵
- ▶ Panoramic sunroof deletion
- ▶ Aluminum Satellite decorative inlays
- ▶ Fine Grain Ash Natural Brown Wood decorative inlays
- ▶ 19" 5-arm Offroad design wheels
- ▶ 20" 10-arm-turbine design wheels



Q5 hybrid instrument panel with MMI® display showing hybrid drive modes



Parking system plus with front and rear acoustic parking sensors Parking system plus with rear view camera parking sensors



Dark Brown Walnut Wood decorative inlays



19" 10-arm-turbine design wheels with 235/55 all-season tires



Adaptive xenon plus headlights with LED daytime running lights



Bang and Olufsen® Sound System



Thermo cup holder



Audi side assist



¹ MMI® navigation plus depends on signals from the worldwide Global Positioning Satellite network. The vehicle's electrical system and existing wireless and satellite technologies must be available and operating properly for the system to function. The system is designed to provide you with suggested routes in locating addresses, destinations and other points of interest. Changes in street names, construction zones, traffic flow, points of interest and other road system changes are beyond the control of Audi of America, Inc. Complete detailed mapping of lanes, roads, streets, toll roads, highways, etc., is not possible, therefore you may encounter discrepancies between the mapping and your actual location. Please rely on your individual judgment in determining whether or not to follow a suggested MMI® navigation plus route. For mapping updates please see your Audi dealer or call 1-800-FOR-AUDI for details. ² Always pay careful attention to the road, and do not drive while distracted. The features and technologies discussed above are optional, may require an additional subscription with separate terms and conditions, and should be used only when it is safe and appropriate. The Wi-Fi® hotspot feature is intended for passenger use only. ³ SiriusXM Satellite Radio and SiriusXM Traffic subscriptions are sold separately or as a package after trial period and are continuous until you call SiriusXM to cancel. See Customer Agreement for complete terms and more information at www.siriusxm.com. SiriusXM Traffic service available in select markets. SiriusXM U.S. Satellite Service available only to those in the 48 contiguous U.S.A., D.C. and Puerto Rico (with coverage limitations). ⁴ Requires compatible device. ⁵ Airbags are supplemental restraints only and will not deploy in all crash circumstances. Always use safety belts and seat children only in the rear, using restraint systems appropriate for their size and age.

Packages

Analogous to the progressive nature in which all our vehicles are engineered are the technologies and offerings available in a variety of packages to enhance the experience of driving an Audi vehicle. To prove that luxury has progressed, we invite you to explore the package that best outfits your Audi Q5.

MMI® navigation plus package

Available on 2.0T Premium models

- ▶ MMI® navigation plus with voice control¹
- ▶ SiriusXM® Traffic with four-year subscription¹
- ▶ Color driver information system
- ▶ HD Radio™ Technology
- ▶ BLUETOOTH® streaming audio¹



Sport Interior package

Available on Premium Plus and Prestige models

- ▶ Audi drive select
- ▶ Black cloth headliner
- ▶ Three-spoke multifunction steering wheel with shift paddles
- ▶ Twelve-way power front sport seats, including four-way power lumbar adjustment



Technology package

Available on Premium Plus models

- ▶ Audi side assist
- ▶ MMI® navigation plus with voice control¹
- ▶ Audi connect® with six-month trial subscription¹
- ▶ SiriusXM® Traffic with four-year subscription¹
- ▶ HD Radio™ Technology¹
- ▶ BLUETOOTH® streaming audio¹
- ▶ Color driver information system
- ▶ Parking system plus with rear view camera (front and rear acoustic parking sensors)

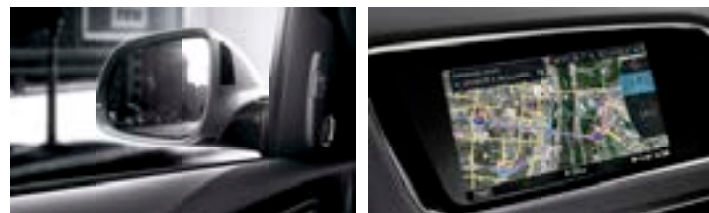

High-gloss Black package

Available on 3.0T Premium Plus and Prestige models

- ▶ Three-spoke multifunction flat-bottom sport steering wheel with shift paddles
- ▶ Matte Black aluminum roof rails
- ▶ Gloss Black Singleframe® grille and Gloss Black trim around exterior windows
- ▶ 20" 5-V spoke design Titanium-finished wheels with 255/45 summer performance tires²



Luxury package

Available on 3.0T/TDI® Premium Plus and 3.0T/TDI®/hybrid Prestige models

- ▶ Twelve-way power ventilated front comfort seats, including four-way power lumbar adjustment
- ▶ Milano leather seats
- ▶ Fine Nappa leather stitched door armrests and instrument panel top



S line® plus package

Available on TDI® Premium Plus and TDI® Prestige models with Sport Interior package

- ▶ S line® exterior appearance
- ▶ Headlight washing system
- ▶ Three-spoke multifunction flat-bottom sport steering wheel with shift paddles
- ▶ Stainless steel door sill inlays with S line® logo
- ▶ Matte Black aluminum roof rails
- ▶ Gloss Black Singleframe® grille and Gloss Black trim around exterior windows
- ▶ 20" 5-V spoke design Titanium-finished wheels with 255/45 summer performance tires²



Driver Assistance package

Available on 3.0T/TDI® Prestige models

- ▶ Dynamic steering
- ▶ Audi drive select
- ▶ Audi adaptive cruise control



Audi exclusive

Audi exclusive line interior package

Available on Prestige models

- ▶ Sport Interior package
- ▶ Fine Nappa bicolor leather seats with contrasting piping and stitching
- ▶ Leather-wrapped door armrests and instrument panel top
- ▶ Contrasting stitching on steering wheel, armrests and gear selector
- ▶ Audi exclusive Piano Black decorative inlays
- ▶ Floor mats with contrasting piping
- ▶ Black cloth headliner

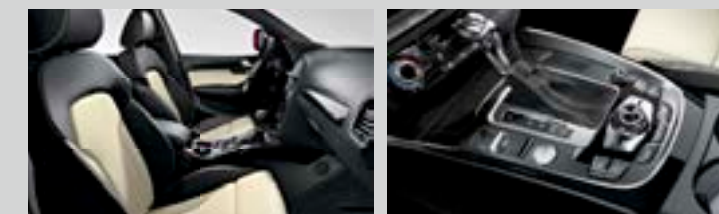

¹ See Infotainment/Technology section of the Featured Content page for important information regarding MMI® navigation plus, required SiriusXM® subscriptions, BLUETOOTH®-compatible device and Audi connect®. ² See Options page for important safety information regarding summer performance tires.

Options

In addition to the many packages available for your Audi Q5, there are also a host of a la carte options to outfit your vehicle. From a variety of wheel offerings and choices of elegant interior trims to features like a premium sound system, rear-passenger thorax side airbags and a panoramic sunroof, there's an option to help better complement your lifestyle.



19" 5-arm star design wheels with 235/55 all-season tires
(optional on Q5 2.0T Premium and Premium Plus)



19" 5-arm Offroad design wheels with 235/55 all-season tires
(optional on Q5 hybrid)



20" 5-arm design wheels with 255/45 summer performance tires¹
(optional on 3.0T/TDI® Premium Plus and 3.0T/TDI® Prestige)



Bang and Olufsen® Sound System
(optional on Premium Plus models)



Heated front seats
(optional on 2.0T Premium)



Panoramic sunroof
(optional on 2.0T Premium)



20" 10-arm turbine design Anthracite bicolor-finish wheels with 255/45 summer performance tires¹
(optional on Q5 hybrid)



Adaptive dampening suspension
(optional on 3.0T Prestige/TDI® Prestige)



Rear-passenger thorax side airbags²
(optional on all models)



Aluminum Satellite decorative inlays



Fine Grain Ash Natural Brown Wood decorative inlays

¹ High-performance tires are designed for better performance and handling in warm climates. When driving in cold, snowy or icy weather, you should equip your vehicle with four all-season or winter tires, which offer better traction under those conditions. We suggest you use the Audi-recommended winter or all-season tires specified for your Audi. High-performance tires also have a lower aspect ratio that aids performance and handling. Driving over rough or damaged road surfaces, as well as debris, curbs and other obstacles, can cause serious damage to wheels, tires, vehicle body and suspension parts. Be careful to avoid road hazards and reduce your speed, especially if your vehicle is equipped with low-profile tires. Please also remember when making your selection that, while these tires deliver responsive handling, they may ride less comfortably and make more noise than others. Finally, these tires may wear more quickly than other choices. It is important that the inflation pressure is regularly checked and maintained at recommended levels. ² Airbags are supplemental restraints only and will not deploy in all crash circumstances. Always use safety belts and seat children only in the rear, using restraint systems appropriate for their size and age.

Exterior Colors

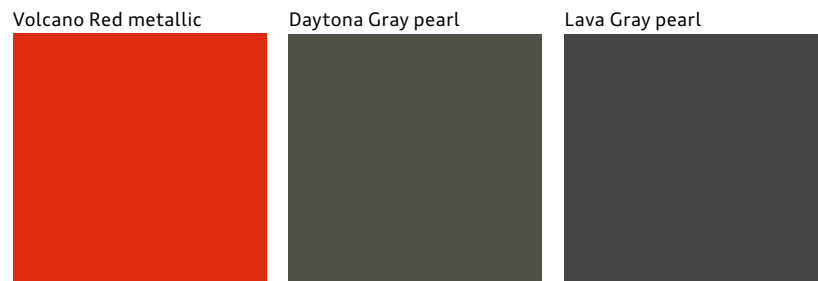
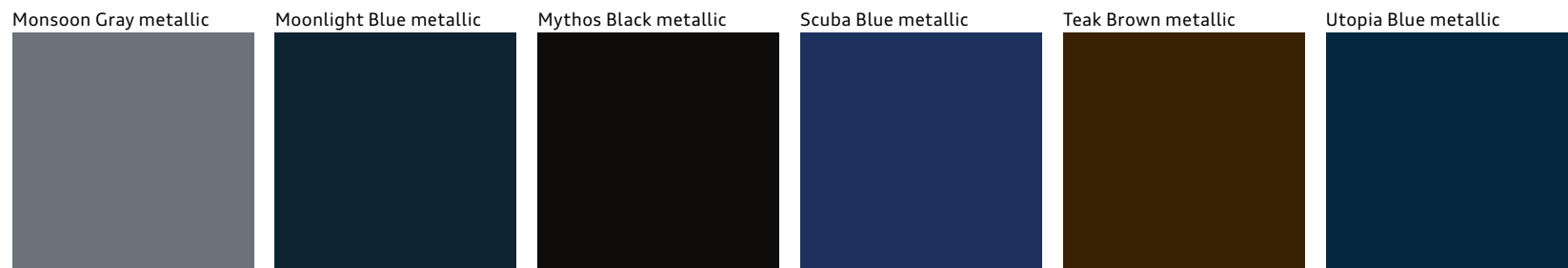

S line®

Exterior colors, interior colors and decorative inlay options will vary based on model and trim level combination. See your dealer for details.

Seat Selections | Interior Colors

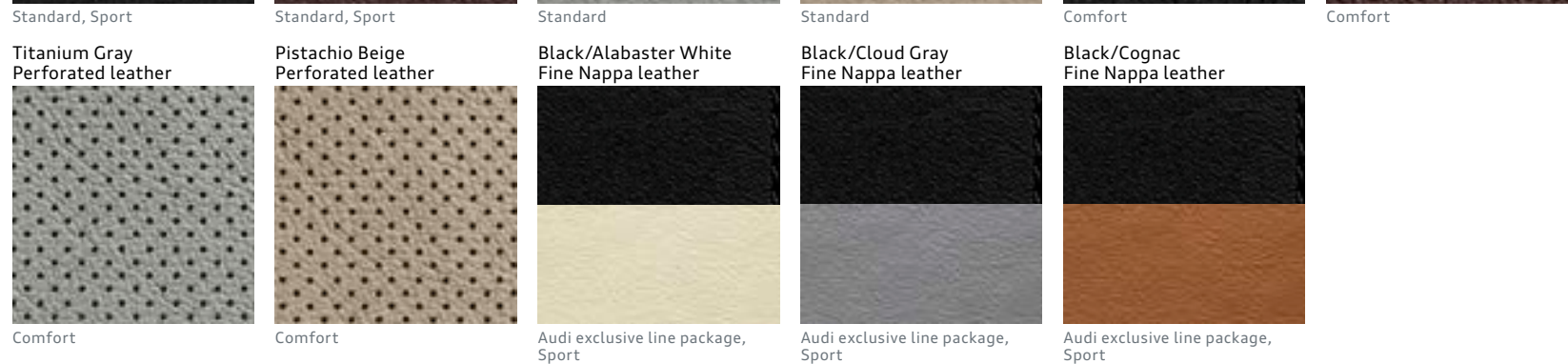
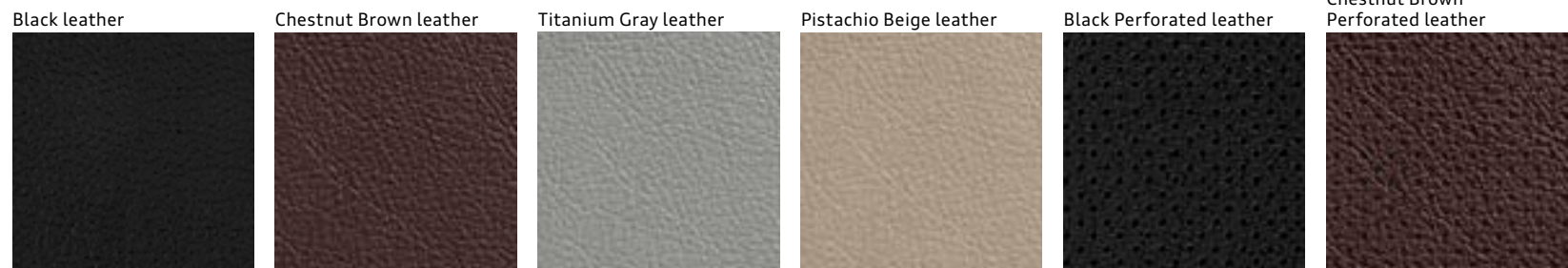

Exterior colors, interior colors and decorative inlay options will vary based on model and trim level combination. See your dealer for details.

Technical Specifications

Engineering Performance	Q5 2.0T	Q5 3.0T	Q5 TDI®	Q5 hybrid
Engine type	Four-cylinder	Six-cylinder	Six-cylinder	Four-cylinder
Engine block/Cylinder head	Cast-iron/ Aluminum-alloy	Aluminum-alloy	Cast-iron/ Aluminum-alloy	Cast-iron/ Aluminum-alloy
Displacement (cc)/Bore and stroke (mm)	1,984/82.5 x 92.8	2,995/84.5 x 89.0	2,967/83.0 x 91.4	1,984/82.5 x 92.8
Horsepower (@ rpm)	220 @ 4,450–6,000	272 @ 4,780	240 @ 3,750–4,000	245 ¹ @ 4,300–6,000
Torque (lb-ft @ rpm)	258 @ 1,500	295 @ 2,150	428 @ 1,750–2,250	350 ¹ @ 1,500–4,200
Compression ratio	9.6:1	10.3:1	16.8:1	9.6:1
Valvetrain	16-valve DOHC with valvelift system	24-valve DOHC	24-valve DOHC	16-valve DOHC with valvelift system
Induction/Fuel injection	Turbocharged/TFSI®	Supercharged/TFSI®	Turbocharged/TDI®	Turbocharged/TFSI®
Start-stop efficiency system	—	■ ²	■ ³	■ ³
54-hp water-cooled three-phase hybrid AC electric motor/generator	—	—	—	■
266-volt, 72-cell, lithium-ion hybrid battery system	—	—	—	■
Acceleration (0–60 mph)	7.0 seconds	6.0 seconds	6.5 seconds	6.8 seconds
Top track speed ⁴	130 mph	130 mph	130 mph	130 mph

Transmission | Drivetrain

Eight-speed Tiptronic® automatic transmission with quattro® all-wheel drive (Gear ratios: 1st: 4.714, 2nd: 3.143, 3rd: 2.106, 4th: 1.667, 5th: 1.285, 6th: 1.000, 7th: 0.839, 8th: 0.667, Reverse: 3.317, Final drive: 3.760 for 2.0T and hybrid models, 3.204 for 3.0T models, 3.076 for TDI® models)	■	■	■	■
---	---	---	---	---

Body | Suspension | Chassis

Fully galvanized steel unibody with aluminum hood and tailgate and multi-step anti-corrosion protection	■	■	■	■
Five-link front suspension	■	■	■	■
Trapezoidal-link rear suspension	■	■	■	■
Adaptive damping suspension (Prestige)	—	Available	Available	—
Ventilated front disc/Solid rear disc brakes (in)	12.6/11.8	—	—	—
Ventilated front disc/Ventilated rear disc brakes (in)	—	13.6/13.0	13.6/13.0	13.6/13.0
Electromechanical power steering system	■	■	■	■
Dynamic steering (Prestige)	—	Available	Available	—
Steering ratio	15.9:1	15.9:1	15.9:1	15.9:1
Turning diameter, curb-to-curb (ft)	38.1	38.1	38.1	38.1

■ Standard — Not applicable NA Information not available at time of printing

Exterior measurements	Q5 2.0T	Q5 3.0T	Q5 TDI®	Q5 hybrid
Wheelbase (in)	110.5	110.5	110.5	110.5
Length (in)	182.6	182.6	182.6	182.6
Height (in)	65.2	65.2	65.2	65.0
Overall width with mirrors (in)	82.2	82.2	82.2	82.2
Overall width without mirrors (in)	74.7	74.7	74.7	74.7
Track front/rear (in)	63.7/63.5	63.7/63.5	63.7/63.5	63.7/63.5
Curb weight (lb)	4,090	4,354	4,475	4,431
Drag coefficient (Cw)	.33	.33	.33	.33
Trailer hitch provision with 4,400-lb maximum towing capacity and 440-lb tongue weight ⁵	■	■	■	■

Interior measurements

Head room with sunroof (in, front/rear)	39.4/39.0	39.4/39.0	39.4/39.0	39.4/39.0
Head room with sunshade (in, front/rear)	38.1/37.7	38.1/37.7	38.1/37.7	38.1/37.7
Leg room (in, front/rear)	41.0/37.4	41.0/37.4	41.0/37.4	41.0/37.4
Shoulder room (in, front/rear)	57.7/56.4	57.7/56.4	57.7/56.4	57.7/56.4
Cargo volume (cu ft, rear seatbacks up/folded)	29.1/57.3	29.1/57.3	29.1/57.3	29.1/57.3
Seating capacity	5	5	5	5

EPA mileage estimates | Capacities

Tiptronic® automatic transmission (city/highway/combined)	NA ²	NA ²	24/31/27 ³	24/30/26 ³
Engine oil (qt)	4.9	7.2	6.8	4.9
Fuel (gal)	19.8	19.8	19.8	19.0
Required fuel	Premium	Premium	Ultra-low-sulfur diesel	Premium

Audi Sport
Truth in Engineering



¹ Combined gasoline engine and electric motor output. ² 2015 EPA estimates not available at time of printing. See www.fueleconomy.gov for updated information. Your mileage will vary and depend on several factors, including your driving habits and vehicle condition. ³ EPA estimates. Your mileage will vary and depends on several factors, including your driving habits and vehicle condition. See www.fueleconomy.gov for details. ⁴ Top track speed is electronically limited in the U.S. Always obey all speed and traffic laws. ⁵ Maximum tow rating when properly equipped with towing accessories. Other accessories and options may reduce maximum towing capacity. See vehicle owner's manual for details.

Technical specifications and featured content for Audi SQ5 can be found in the **2015 Audi Sport brochure**. See your dealer or go to audiusa.com for details.

Featured Content

Safety Security	2.0T Premium	2.0T Premium Plus	3.0T/TDI® Premium Plus	3.0T/TDI®/hybrid Prestige
Driver and front passenger dual-stage airbags, front thorax side airbags and Sideguard® head curtain airbags ¹	■	■	■	■
Rear-passenger thorax side airbags ¹	Available	Available	Available	Available
Front passenger occupant detection for airbags ¹	■	■	■	■
Safety belt reminder for driver and front passenger	■	■	■	■
Lower Anchors and Tethers for Children (LATCH) in rear seats	■	■	■	■
Power central locking system with safety unlock feature if airbags deploy	■	■	■	■
Electronic Stability Control (ESC) with Offroad mode and traction control (ASR)	■	■	■	■
Anti-lock Brake System (ABS) with Electronic Brake-pressure Distribution (EBD) and brake assist	■	■	■	■
Tire-pressure monitoring system	■	■	■	■
Electromechanical parking brake	■	■	■	■
Anti-theft alarm system with immobilizer	■	■	■	■

Exterior

Singleframe® grille	■	■	■	■
Gloss Black Singleframe® grille	—	—	Available	Available/Available/—
Xenon plus headlights with LED daytime running lights	■	■	■	—
Adaptive xenon plus headlights with LED daytime running lights	—	—	—	■
Headlight washing system	—	—	■/Available	■/Available/—
Front and rear fog lights	■	■	■	■
LED taillights	■	■	■	■
Power-adjustable heated exterior side mirrors	■	—	—	—
Power-adjustable, power-folding, auto-dimming, heated exterior side mirrors with memory	—	■	■	■
LED turn indicator lights integrated into the exterior side mirrors	■	■	■	■
Aluminum roof rails	■	■	■	■
Matte Black aluminum roof rails	—	—	Available	Available/Available/—
Aluminum trim around exterior windows	■	■	■	■
Gloss Black trim around exterior windows	—	—	Available	Available/Available/—
Power tailgate	■	■	■	■
Flat-bottom dual exhaust outlets with polished tips	■	■	■	■
S line® exterior appearance	—	—	■/Available	■/Available/—

¹ Airbags are supplemental restraints only and will not deploy in all crash circumstances. Always use safety belts and seat children only in the rear, using restraint systems appropriate for their size and age.

Interior

	2.0T Premium	2.0T Premium Plus	3.0T/TDI® Premium Plus	3.0T/TDI®/hybrid Prestige
Three-zone automatic climate control	■	■	■	■
Four-spoke multifunction steering wheel	■	■	—	—
Three-spoke multifunction steering wheel	—	—	■	■
Three-spoke multifunction steering wheel with shift paddles	—	Available	Available	Available
Three-spoke multifunction flat-bottom sport steering wheel with shift paddles	—	—	Available	Available/Available/—
Tilt and telescopic manually adjustable steering column	■	■	■	■
Auto-dimming interior rear view mirror with digital compass	—	■	■	■
Illuminated locking glove compartment	■	■	■	■
Leather-wrapped shift knob	■	■	■	■
Folding and sliding front center armrest with height adjustment	■	■	■	■
Eight beverage holders (four cup and four bottle)	■	■	■	■
Thermo cup holder	—	—	—	■
Decorative interior inlays	■	■	■	■
Stainless steel door sill inlays	—	■	■	■
Ambient LED interior lighting	■	■	■	■
Black cloth headliner	Available	Available	Available	Available
Dual front sun visors with lighted vanity mirrors	■	■	■	■
Power windows with one-touch up/down operation and pinch protection	■	■	■	■
Manual rear-side sunshades	—	—	—	■
Panoramic sunroof	Available	■	■	■
Panoramic sunroof deletion	—	Available	Available	Available

Seating

Leather seating surfaces	■	■	■	■
Perforated Milano leather seats, stitched door armrests and instrument panel top in Fine Nappa leather	—	—	Available	Available
Audi exclusive line bicolor Fine Nappa leather seats	—	—	—	Available
Eight-way power front seats and four-way power lumbar adjustment for driver	■	■	■	■
Twelve-way power front seats, including four-way power lumbar adjustment	—	Available	Available	Available
Driver seat memory	—	■	■	■
Heated front seats	Available	■	■	■
Ventilated front seats	—	—	Available	Available
Sliding 40/20/40 split folding rear seat with pass-through and adjustable recline	■	■	■	■

Featured Content

Infotainment Technology	2.0T Premium	2.0T Premium Plus	3.0T/TDI® Premium Plus	3.0T/TDI®/hybrid Prestige
MMI® navigation plus with voice control system ¹	Available	Available	Available	■
Audi connect® with six-month trial subscription ²	—	Available (with navigation)	Available (with navigation)	■
Driver information system	■	■	■	—
Color driver information system	Available (with navigation)	Available (with navigation)	Available (with navigation)	■
Audi concert radio with ten speakers and single CD player with MP3 playback capability	■	■	■	—
Bang & Olufsen® Sound System with 14 speakers and 505 watts	—	Available	Available	■
HD Radio™ Technology	Available (with navigation)	Available (with navigation)	Available (with navigation)	■
SiriusXM® Satellite Radio with 90-day trial subscription ³	■	■	■	■
SiriusXM® Traffic with four-year subscription ³	Available (with navigation)	Available (with navigation)	Available (with navigation)	■
SD card slot with 32GB operating capacity (dual slots if equipped with MMI® navigation plus) ¹	■	■	■	■
Audi music interface with iPod® integration	■	■	■	■
BLUETOOTH® streaming audio ⁴	Available (with navigation)	Available (with navigation)	Available (with navigation)	■
BLUETOOTH® wireless technology preparation for mobile phone ⁴	■	■	■	■
Four 12-volt power outlets	■	■	■	■
Garage door opener (HomeLink®)	■	■	■	■
Audi advanced key—keyless start, stop and entry ⁵	—	■	■	■
Cruise control with coast, resume and accelerate features	■	■	■	■
Audi adaptive cruise control	—	—	—	Available/Available/—
Audi side assist	—	Available	Available	■
Audi drive select	—	Available	Available	Available/Available/—
Parking system plus with rear view camera (front and rear acoustic parking sensors)	—	Available	Available	■
Rain/light sensor for automatic windshield wipers and headlights	■	■	■	■

■ Standard — Not applicable

¹ MMI® navigation plus depends on signals from the worldwide Global Positioning Satellite network. The vehicle's electrical system and existing wireless and satellite technologies must be available and operating properly for the system to function. The system is designed to provide you with suggested routes in locating addresses, destinations and other points of interest. Changes in street names, construction zones, traffic flow, points of interest and other road system changes are beyond the control of Audi of America, Inc. Complete detailed mapping of lanes, roads, streets, toll roads, highways, etc., is not possible, therefore you may encounter discrepancies between the mapping and your actual location. Please rely on your individual judgment in determining whether or not to follow a suggested MMI® navigation plus route. For mapping updates please see your Audi dealer or call 1-800-FOR-AUDI for details. ² Always pay careful attention to the road, and do not drive while distracted. The features and technologies discussed above are optional, may require an additional subscription with separate terms and conditions, and should be used only when it is safe and appropriate. The Wi-Fi® hotspot feature is intended for passenger use only. ³ SiriusXM Satellite Radio and SiriusXM Traffic subscriptions are sold separately or as a package after trial period and are continuous until you call SiriusXM to cancel. See Customer Agreement for complete terms and more information at www.siriusxm.com. SiriusXM Traffic service available in select markets. SiriusXM U.S. Satellite Service available only to those in the 48 contiguous U.S.A., D.C. and Puerto Rico (with coverage limitations). ⁴ Requires compatible device. ⁵ Some Audi models are equipped with a keyless ignition feature. The details as to how the system works can vary, and Audi owners should consult their owner's literature or an authorized Audi dealer if they have further questions about the operation of this feature. Please note that Audi warns against leaving the vehicle unattended with the engine running, particularly in enclosed spaces.

Without question, a product of your mind.

We have concentrated all the benefits of an Audi exclusive vehicle into the Audi exclusive line package so that you can outfit your Audi Q5 with an even more unmistakable look. By combining some of the most popular offerings, the Audi exclusive line package boasts a considerable cost advantage and simplifies the ordering and consultation process, making your first step into the realm of Audi exclusive an easy and uncomplicated process. We've clearly taken luxury to the next level, putting you in charge of choosing a package that is unmistakably yours.



Accessories

Add distinction, versatility and the ultimate in self-expression with Audi Genuine Accessories. Whether you load the cargo carrier with climbing gear or add a set of stylish new wheels, we have the accessories that will help enhance every facet of your lifestyle. When purchased from an authorized dealer, all pieces are backed

by your vehicle's 4-year/50,000-mile limited warranty, or for 12 months/12,000 miles from the accessory purchase date, whichever is greater.¹ If you're looking to personalize or protect the vehicle you love, we have an Audi-designed solution that works for you.



Trailer hitch

This towing hitch is approved for a maximum load-carrying capacity of 4,400 lb for a properly equipped Audi Q5. For more information on towing, contact your dealer or see your owner's manual.

Base carrier bars storage bag

This rugged, ballistic-nylon bag has ample space for the side brackets and base carrier bars of the Audi roof-rack system.



Ski and snowboard rack

This rack transports your equipment to the slopes easily and securely. The standard attachment (shown) holds two sets of skis or two snowboards. A deluxe attachment is also available.^{2,3}

Compact cargo carrier

Your gear won't take up valuable trunk space with our aerodynamic carrier that offers a generous 16.95-cu-ft capacity. Size: 81" long, 30" wide, 15" high.²



Aluminum bike rack

This locking holder fits 20- to 80-mm bike frames with both wheels on the bike and helps keep the bike upright as you secure it in place.^{2,3}

Splash guards

Help protect the finish of your Q5 with custom-fit splash guards made of crack-resistant rubber. They are available in sets of two for front or rear.



All-weather cargo mat

Custom fit for your Q5, the raised outside edge of the cargo mat helps contain spills and protect cargo-area carpeting from stains. The textured material helps control load shifting.

Cargo net

Help secure almost anything, from groceries to sports gear, with this expandable net. It hooks to tie-downs in the cargo area and easily adapts to items of different shapes and sizes.



Premium textile floor mats

These skid-resistant, precision-fit mats are made of long-life fabric to help protect your vehicle's interior from the elements. Mats are black with silver piping, and available in a set of four.

Q5 all-weather floor mats

Nubbed design helps protect your vehicle's floor and carpeting from water, mud, sand and snow. Black mats are available in sets of two for front or rear. Front mats feature the Q5 logo.



20" 10-spoke wheels

Add a more powerful, sporty look with this eye-catching design. Shown in silver. Also available in anthracite.

20" 7-V design wheels

Give your vehicle a more unique presence with this Audi designed silver wheel.

Other accessories

Audi Genuine Sport and Design Accessories

Your Audi vehicle features a bold, aggressive stance and strong, stunning lines. Enhance it by adding Audi Genuine Sport and Design accessories. All are carefully scrutinized in the design and development process. So while they're striking in appearance, they've also passed rigorous quality assessments, including corrosion testing. If you're looking for a bolder appearance or a finishing touch, there is a solution designed by Audi that makes every mile more enjoyable—and more yours.

Audi Genuine Alloy Wheels

Strike the perfect balance between breathtaking design and awe-inspiring performance with Audi Genuine Alloy Wheels. Audi experts have meticulously designed these wheels especially for each Audi model. They're engineered to the highest standards and endure rigorous testing to help ensure long-term quality. Experience eye-catching style that is yours and yours alone. Nothing enhances the bold, dynamic look of your Audi vehicle faster.

Audi TravelSpace Transport Accessories

For every season and every getaway, Audi takes you there. Never leave the necessary gear behind. Be ready for any journey with Audi TravelSpace Transport Accessories. The list includes bike racks, ski racks, and various sizes of cargo carriers. Wherever you go, make sure everything fits with a variety of intelligent and innovative solutions. Accessories designed for your active, passionate lifestyle.

Audi Genuine Electronics Accessories

The illuminating technology that graces each Audi vehicle provides the inspiration for Audi Genuine Electronics Accessories. Similarly, all of these accessories are impressively advanced and inspiring. Our audio options let you enhance your listening pleasure. Other accessory options help promote more convenient travel. All are designed and tested to help ensure compatibility with the vehicle's electrical systems, allowing you to enjoy every aspect of Audi technology with almost all your senses. Demand the best and drive with added confidence.

Audi Genuine Comfort and Protection Accessories

Help protect what you love. Audi Guard Comfort and Protection Accessories offer functional, practical items that help keep your Audi in pristine condition. Choose from such useful items as trunk liners that help make clean-up quick and easy, or an easy-to-use storage cover that helps shield the vehicle. Use them all to help reduce wear and tear and keep the vehicle looking like new—inside and out. All are engineered to stringent Audi standards, so you can be assured of their quality and durability.

¹ Audi Genuine Accessories purchased from an authorized Audi dealer are covered for the greater of: (1) the accessory limited warranty period (12 months or 12,000 miles, whichever occurs first) from the time of purchase; or (2) the remainder of the Audi New Vehicle Limited Warranty period (4 years or 50,000 miles, whichever occurs first). See your authorized Audi dealer for details. ² All roof-rack system attachments require the base carrier bars. All attachments sold separately. ³ Recreational equipment, sporting equipment and luggage not included.

Note: A word about this brochure. Audi of America, Inc., believes the specifications in this brochure to be correct at the time of printing. However, specifications, standard equipment, options, fabrics, and colors are subject to change without notice. Some equipment may be unavailable when your vehicle is built. Please ask your dealer for advice concerning current availability of standard and optional equipment, and your dealer will verify that your vehicle will include the equipment you ordered. Vehicles in this brochure are shown with optional equipment. See your dealer for complete details on the Audi New Vehicle Limited Warranty, twelve-year limited warranty against corrosion perforation, and Audi 24/7 Roadside Assistance. (Roadside assistance coverage provided by Road America in the U.S. Certain conditions apply; see your dealer for details.) Tires supplied by various manufacturers. "Audi," all model names, "Audi connect," "e-tron," "FSI," "MMI," "quattro," "Sideguard," "Singleframe," and the Singleframe grille design, "S line," "TFSI," "Truth in Engineering," "ultra," and the four rings logo are registered trademarks of AUDI AG. "ADBlue" is a registered trademark of the Verband der Automobilindustrie. "Bang & Olufsen" is a registered trademark of Bang & Olufsen. The BLUETOOTH word mark and logos are owned by the Bluetooth SIG, Inc., and any use of such marks by AUDI AG is under license. "Google," "Google Earth" and "Google Voice" are trademarks of Google, Inc. "Homelink" is a registered trademark of Johnson Controls Technology Company. "HD Radio" and the HD Radio logo are proprietary trademarks of iBiquity Digital Corporation. "iPod" is a registered trademark of Apple Inc. "SiriusXM" and all related marks and logos are trademarks of Sirius XM Radio Inc. and its subsidiaries. "TDI" is a registered trademark of Volkswagen AG. "Tiptronic" is a registered trademark of Dr. Ing h.c. F. Porsche AG. "Wi-Fi" is a registered trademark of the Wi-Fi Alliance. All other trademarks are the property of their respective owners. Some European models shown.

2015 | Q5 Audi of America

AudiUSA.com

Facebook.com/Audi

AoA1515492



© 2014 Audi of America, Inc. Printed in the U.S.A.