

A BOLD STATEMENT AGAINST COMPROMISE

2013 GMC YUKON

WE ARE PROFESSIONAL GRADE.

GMC



2013 GMC YUKON

GMC is dedicated to pushing the limits of what's possible. Our commitment is to one ideal: building professional-grade vehicles that are engineered to offer the best in performance, innovation and versatility. Like you, GMC believes that just being good enough is never enough and jobs worth doing are worth doing right.

It's why the 2013 Yukon was engineered to keep you comfortably in command without having to compromise. It's why Yukon Hybrids have the best-in-class fuel economy¹ and why Yukon XL models offer the most cargo capacity² behind the first, second and third rows.

GMC. We Are Professional Grade.

MODELS

GMC YUKON DENALI pg. 2

GMC YUKON SLT pg. 6

GMC YUKON LINEUP pg. 10

FEATURES & BENEFITS pg. 12

COLOR & TRIM pg. 22

ACCESSORIES pg. 25

FEATURES & OPTIONS pg. 26



YUKON DENALI HYBRID IN WHITE DIAMOND TRICOAT shown with available equipment.



HYBRID DRIVETRAIN (upper)

Professional-grade engineering gives Yukon Denali Hybrid best-in-class fuel economy, with up to 66 percent better city fuel economy than any other full-size SUV.¹

20" CHROME WHEELS (lower)

Denali comes standard with 20" 8-spoke chrome-finished cast-aluminum wheels. Their lustrous finish complements the chrome accents, giving Denali its bold look.



YUKON DENALI A SUPERLATIVE EXPRESSION OF PROFESSIONAL-GRADE ENGINEERING.

Yukon Denali and Yukon Denali Hybrid let you take on anything with comfort and style. Denali includes a distinctive honeycomb chrome grille, chrome-accented bodyside molding and 20" chrome wheels standard (22" on Denali Hybrid). Yukon XL Denali is even more daring, combining all of the above with a class-leading 137.4 cubic feet of maximum cargo space.² Opt for the Denali Hybrid, which offers 20 mpg in the city and 23 mpg on the highway,¹ and let the world know you believe being efficient doesn't mean compromising on comfort.

SELECT DENALI FEATURES

For details, see corresponding page in Features & Benefits, starting on page 12.

6.2L V-8 VVT Engine	pg. 12	AutoRide Real-Time Damping	pg. 14
Best-in-Class 403 Horsepower	pg. 12	All-Wheel Drive (Available)	pg. 14
Best-in-Class 417 lb-ft Torque	pg. 12	20" Chrome Wheels	pg. 23

¹EPA-estimated mpg 20 city/23 highway. Based on 2012 GM Large Utility segment. ²Cargo and load capacity limited by weight and distribution.



YUKON XL DENALI IN ONYX BLACK (left)
YUKON DENALI IN ONYX BLACK (right)
Vehicles shown with available equipment.



YUKON DENALI INTERIOR ENJOY THE LUXURY OF COMMAND.

Modern lifestyles bring modern challenges, like staying connected while staying in command of your Yukon. To that end, Yukon Denali has various technologies to keep you in touch, informed and in charge.

SELECT INTERIOR FEATURES

For details, see corresponding page in Features & Benefits, starting on page 12.

12-Way Heated and Cooled Front Seats	pg. 17	Steering-Wheel-Mounted Controls	pg. 17
Tri-Zone Climate Control	pg. 17	Bluetooth ^{®1} for Phone	pg. 18
Heated Steering Wheel	pg. 17	Touch-Screen Navigation System ²	pg. 18

¹Go to gm.com/bluetooth to find out which Bluetooth phones are compatible with the vehicle. ²Map coverage for Puerto Rico and the Virgin Islands available on separate disc. Coverage not available for portions of Canada. ³Before making a lane change, always check the SBZA display, check the side and inside rear mirrors, look over your shoulder for vehicles and hazards and start the turn signal.



YUKON DENALI INTERIOR IN EBONY shown with available equipment.



BOSE® CENTERPOINT® SURROUND SOUND SYSTEM (upper)

Deep lows and crisp highs come from the Bose Centerpoint 10-speaker surround sound system with center console subwoofer.

SIDE BLIND ZONE ALERT³ (center)

Alternating radar beams sweep a zone approximately one lane over from each side of your Yukon Denali. An amber icon in the outside rearview mirror lights if a vehicle is in the blind spot and flashes if you activate the turn signal.

HYBRID POWER FLOW DISPLAY (lower)

When Denali is equipped with the hybrid drivetrain, the center navigation screen can also function as a power flow display, letting you monitor the hybrid system.



HEAVY-DUTY HANDLING/TRAILERING SUSPENSION (upper)

Yukon XL features a 3/4-ton model with a trailer weight rating of up to 9600 lbs,¹ not offered by any competitor, and a maximum weight carrying capacity for passengers and cargo of up to 2459 lbs.²

STABILITRAK STABILITY CONTROL SYSTEM (lower)

StabiliTrak uses a network of vehicle sensors to monitor your Yukon and help you stay in control in unfavorable road conditions.



YUKON CAPABILITY WITHOUT COMPROMISE.

Every engineering decision in the GMC Yukon came about by defying convention. Choose the 5.3L V-8 with uncompromising power across a wide rpm range while simultaneously offering 21 mpg on the highway. Our Hybrid drivetrain offers a class-leading EPA-estimated 20 mpg in the city³ while retaining the ability to tow up to 6200 pounds.¹ For maximum capability, the Vortec 6.0L V-8 equipped Yukon XL 3/4-ton has class-leading cargo and towing capacity.

SELECT YUKON FEATURES

For details, see corresponding page in Features & Benefits, starting on page 12.

5.3L V-8 Engine	pg. 12	Variable Valve Timing	pg. 12
320 Horsepower	pg. 12	StabiliTrak Stability Control System	pg. 14
Active Fuel Management	pg. 12	20" Aluminum Wheels [Available]	pg. 23



ACTIVE FUEL MANAGEMENT

■ Active Fuel Management deactivates four of the eight cylinders when they aren't needed. All eight cylinders reactivate seamlessly when you need extra power.

¹Maximum trailer weight ratings are calculated assuming a base vehicle, except for any option(s) necessary to achieve the rating, plus driver. The weight of other optional equipment, passengers and cargo will reduce the maximum trailer weight your vehicle can tow. See your GMC dealer for additional details. ²Maximum payload capacity includes weight of driver, passengers, optional equipment and cargo. ³Based on 2012 GM Large Utility segment.



YUKON XL SLT IN QUICKSILVER METALLIC shown with available equipment.

YUKON INTERIOR ACCOMMODATING LUXURY.

With available features you won't find in any other competitor, like the power-release fold-and-tumble second-row seats,¹ seating for up to nine and Touch-Screen Navigation² with pause-and-play capability, Yukon turns any trip into a luxury cruise.

SELECT YUKON FEATURES

For details, see corresponding page in Features & Benefits, starting on page 12.

Power-Adjustable Front Bucket Seats pg. 17

Nine-Passenger Seating (Available) pg. 17

Tri-Zone Climate Control pg. 17

Steering-Wheel-Mounted Radio Controls pg. 17

FOLD-AND-TUMBLE SEATS

■ The second-row seats fold and tumble out of the way with simple one-hand operation.¹

SEATING CONFIGURATIONS

■ Yukon with the available 40/20/40 front split bench seat comfortably accommodates up to nine passengers.

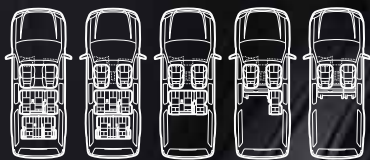

¹Not available on SLE and Hybrid models. ²Map coverage for Puerto Rico and the Virgin Islands available on separate disc. Coverage not available for portions of Canada.



YUKON SLT INTERIOR IN EBONY shown with available equipment.



REMOTE POWER LIFTGATE (upper left)

Loading up your Yukon with your hands full? Let us help you with that. The available power liftgate opens with a touch of your key fob for easier access to your Yukon's impressive cargo capacity. You can close it the same way, or use the switch located on the liftgate itself or on the overhead center console.

TOUCH-SCREEN NAVIGATION SYSTEM² (upper right)

Yukon's available Touch-Screen Navigation System with a hard drive that can store up to 30 GB of music provides advanced entertainment and turn-by-turn mapping capabilities.

REAR-VISION CAMERA SYSTEM (lower)

This available feature uses the rearview mirror to display a view to the rear of your Yukon. When equipped, the camera displays in the navigation radio screen.

THE YUKON LINEUP

CONFIDENCE RUNS IN THE FAMILY.

Every Yukon includes a 6-month trial subscription to OnStar Directions & Connections,¹ which provides verbal guidance to any destination, and 3 months of access to SiriusXM Satellite Radio's² 140+ channels. The Touch-Screen Navigation System, standard on Denali and Hybrid models, includes a 3-month trial of NavTraffic² (3 years for Hybrid owners). Our outstanding 5-Year/100,000-Mile Powertrain Limited Warranty³ comes with the added convenience of courtesy transportation⁴ and 24/7 roadside assistance. It's also standard with every Yukon.

SELECT YUKON FAMILY FEATURES

For details, see corresponding page in Features & Benefits, starting on page 12.

StabiliTrak	pg. 14	4-Wheel ABS Disc Brakes	pg. 15
5-Star Overall Frontal Crash Safety Rating ⁵	pg. 21	5-Star Overall Side Crash Safety Rating ⁵	pg. 21
6 Months OnStar Directions & Connections ¹	pg. 19	6 Passenger Compartment Air Bags ⁶	pg. 21

¹Go to onstar.com for coverage map, details and system limitations. ²If you subscribe after your trial period, subscriptions are continuous until you call SiriusXM to cancel. See SiriusXM Customer Agreement for complete terms at siriusxm.com. Other fees and taxes will apply. All fees and programming subject to change. For more information about NavTraffic, visit siriusxm.com/navtraffic. For more information about Travel Link, visit siriusxm.com/travelink. XM satellite service is available only to those in the 48 contiguous USA and DC. ³Whichever comes first. See dealer for details. ⁴Available only at participating dealers. See page 29 for details. ⁵Government 5-Star Safety Ratings are part of the National Highway Traffic Safety Administration's (NHTSA's) New Car Assessment Program (safercar.gov). ⁶Always use safety belts and child restraints. Children are safer when properly secured in a rear seat in the appropriate child restraint. See the Owner's Manual for more information.





YUKON HYBRID IN QUICKSILVER METALLIC (left)
YUKON XL DENALI IN ONYX BLACK (center)
YUKON SLT IN QUICKSILVER METALLIC (right)
Vehicles shown with available equipment.

ENGINES

Yukon's Vortec V-8 VVT engines offer uncompromising power, torque and efficiency. The 5.3L V-8 is tuned to deliver power across a wide rpm range while the available 6.2L V-8 provides the most horsepower and torque in the full-size SUV class. Active Fuel Management, included on both engines and the standard 6.0L V-8 in Hybrid models, proves that a full-size SUV can offer outstanding performance and class-leading fuel economy.¹ Yukon ¾-ton models mate the 6.0L V-8 with a 6-speed automatic transmission to provide a maximum trailer weight rating of up to 9600 pounds.²

¹EPA-estimated 16 city/21 hwy (gas), 20 city/23 hwy (hybrid). Based on 2012 GM Large Utility Segment. ²Maximum trailer weight ratings are calculated assuming a base vehicle, except for any option(s) necessary to achieve the rating, plus driver. The weight of other optional equipment, passengers and cargo will reduce the maximum trailer weight your vehicle can tow. See your GMC dealer for additional details.

1



2

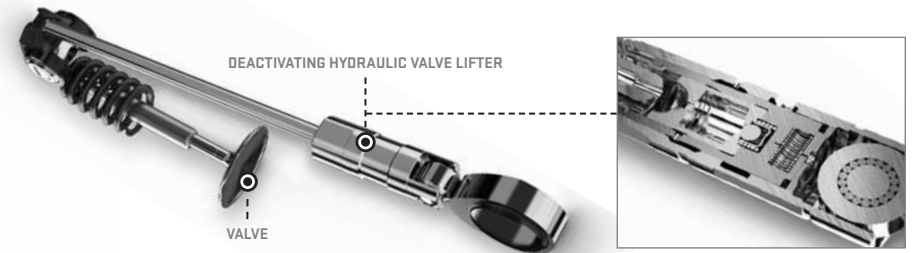

1 VORTEC 5.3L V-8 VVT (LMG)/(LC9) Active Fuel Management/FlexFuel Capable
HORSEPOWER: 320 hp @ 5400 rpm TORQUE: 335 lb-ft @ 4000 rpm

VORTEC 6.0L V-8 VVT (L96) ¾-ton Models Only
HORSEPOWER: 352 hp @ 5400 rpm TORQUE: 382 lb-ft @ 4200 rpm

VORTEC 6.2L V-8 VVT (L94) Active Fuel Management/FlexFuel Capable
HORSEPOWER: 403 hp @ 5700 rpm TORQUE: 417 lb-ft @ 4300 rpm

VORTEC 6.0L V-8 VVT HYBRID (LZ1 - HYBRID ONLY) Active Fuel Management
HORSEPOWER: 332 hp @ 5100 rpm TORQUE: 367 lb-ft @ 4100 rpm

2 ACTIVE FUEL MANAGEMENT

(AFM) For maximum fuel economy when your load is light, and maximum V-8 power when it isn't, AFM (not available on ¾-ton 6.0L V-8) senses load and demand then seamlessly activates or deactivates four of the engine's eight cylinders, using specially designed hydraulic valve lifters. It's innovative technology that results in better fuel economy³ than any other competitor.

³EPA-estimated 16 city/21 hwy. Based on 2012 GM Large Utility Segment.

E85 FLEXFUEL CAPABILITY⁴

To give you more choices at the pump, two Yukon Vortec V-8 engines are capable of running on E85 ethanol. This advanced biofuel is a mostly renewable fuel that burns cleaner than gasoline and helps to reduce vehicle emissions, as well as the need for imported oil.

⁴E85 is a blend of 85 percent ethanol and 15 percent regular gasoline. Go to gmc.com and search E85 for more information about E85 as a fuel alternative.

VARIABLE VALVE TIMING (VVT)

To give you the maximum power over the widest range of engine speeds, VVT changes the engine's performance profile to match the driving situation. In city driving, VVT gives you a smooth idle and quick response at low speeds. On the highway, VVT changes your engine to a bold, high performance V-8 with horsepower to spare.

TRANSMISSION

Every Yukon comes with a transmission designed to intelligently transfer power to the road. Non-hybrid models feature 6-speed electronic shifting and Automatic Grade Braking to help you feel confident behind the wheel. Driver Shift Control and Tow/Haul mode give additional control when needed.

3

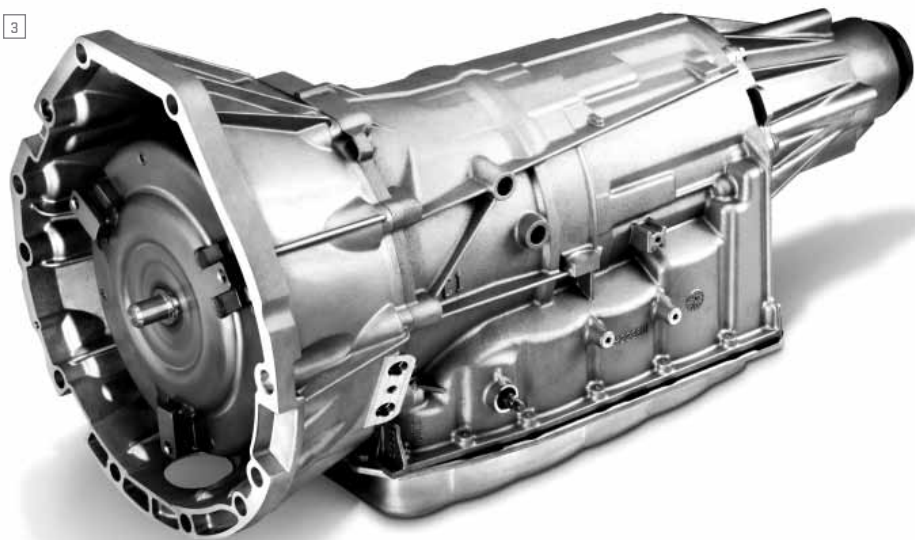

3 6-SPEED AUTOMATIC OVERDRIVE TRANSMISSION
Engineered for control and confidence in a wide variety of situations, the 6-speed automatic is standard in all non-hybrid Yukon models. It's an ideal partner for Vortec power. Filled with innovative technology, this transmission can help you cut steep climbs, long grades and heavy loads down to size.

AUTOMATIC GRADE BRAKING
Standard with 6-speed automatic transmissions, Grade Braking automatically senses when you want to slow your Yukon, and when the conditions are met, engages a Grade Braking shift schedule that helps you maintain your desired speed.

TOW/HAUL MODE This feature changes transmission points to reduce shift business while trailering or driving up or down hills.

DRIVER SHIFT CONTROL
Standard on all models, this feature lets you move through the gear ranges. Move the shift lever to "M," and you get fingertip "tap up/down" control of transmission gear range selection.

HYBRID

Yukon's EPA-estimated 20 city/23 highway mpg Hybrid system tips the balance between size and fuel economy in your favor. The electronically variable transmission combines integral electric motors with the gas engine's output, giving you improved fuel economy and power on demand.

4

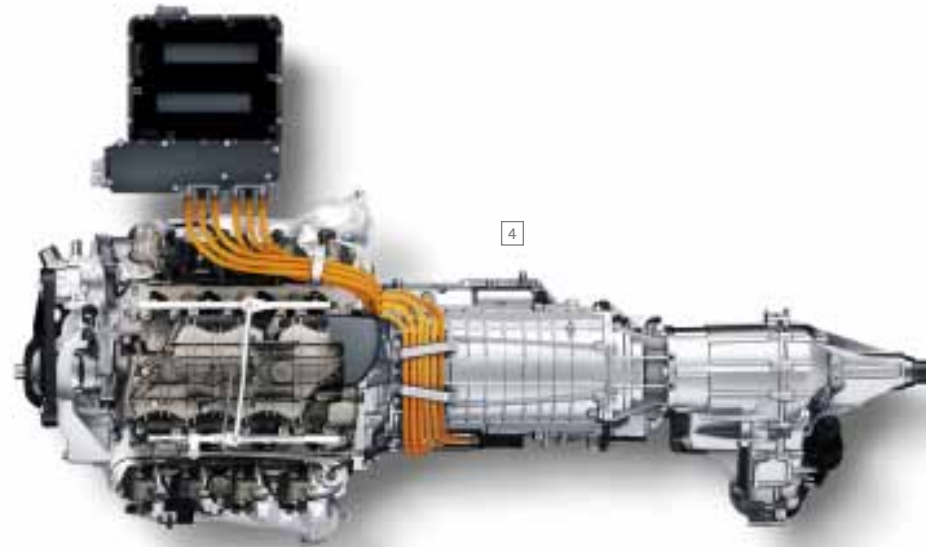

300-VOLT NICKEL-METAL HYDRIDE (NiMH) BATTERY PACK
NiMH battery technology can store a lot of energy in a small space. In fact, the 300-volt battery pack is strong enough to propel your Yukon from rest to over 25 mph on electric power alone, yet small enough to fit under the second-row seat between the steel frame rails. This leaves your cargo space and passenger capacity unchanged from other Yukon models.

REGENERATIVE BRAKING SYSTEM
During normal deceleration, regenerative braking uses the motors in the hybrid transmission as generators to slow the vehicle by applying electrical resistance, rather than using brake friction. At the same time, the motors are capturing that energy as electricity in the 300-volt battery pack, making that energy available for the next acceleration cycle.

4 HYBRID ELECTRONICALLY VARIABLE TRANSMISSION
To conserve fuel at low speeds or under light loads, this transmission has two integral electronic motors that engage to give you smooth, effortless power. At highway speeds or heavier loads with its 6.0L V-8 VVT engine engaged, it acts as a normal automatic transmission.

CHASSIS & SUSPENSION

Yukon's strong frame and rigid body structure keep road harshness out while preserving responsiveness under any load condition. On half-ton models, a fully independent front suspension and multilink rear suspension are coupled with advanced technology like StabiliTrak, antilock brakes, traction control and available rear level control to provide a premium ride without sacrificing agility.

5



6



5 REAR MULTILINK SUSPENSION WITH COIL SPRINGS

To give you a smooth, refined ride under a variety of road conditions, Yukon 1500 Series models are equipped with a standard five-link coil spring rear suspension. For extra load-carrying capacity, the Yukon XL 2500 uses parallel leaf springs in place of coils.

ALL-WHEEL DRIVE The available All-Wheel Drive system on Denali transfers power to all four wheels all the time. It is always activated, so you don't have to fuss with controls to enjoy the benefits of improved control.

6 AUTORIDE REAL-TIME DAMPING

Engineered to eliminate the compromise between a comfortable ride and precise control, the available AutoRide System senses changes in the road surface and adjusts the shock absorbers as you drive.

REAR LEVEL CONTROL This system is included with the available AutoRide System (and Magnetic Ride Control on Denali Hybrid) to constantly sense and adjust rear suspension height for a level ride height under varying load or passenger conditions. Available on SLT and standard on Denali models, this system uses an onboard compressor that pressurizes the air bladders until the Yukon is at level.

STABILITRAK STABILITY CONTROL SYSTEM

The StabiliTrak stability control system helps you stay on the path you are steering in bad weather or on uneven road surfaces. The system senses when your vehicle is not responding to your steering inputs, then adjusts engine speed and braking pressure to any individual wheel to help maintain directional control.

TRAILER SWAY CONTROL

Keep both you and your trailer heading in the proper direction, automatically. This system uses StabiliTrak sensors to detect the rocking of a swaying trailer, and then applies the vehicle's brakes and the trailer brakes (if properly equipped) to bring it back in line. (Not available on Hybrid models.)

TRACTION CONTROL SYSTEM

To make the most of available traction on many road surfaces, traction control measures and compares the speed of your wheels. If it senses one or more wheels starting to spin, such as on a slippery surface, the system applies individual brakes and manages engine power to slow the wheel down and maintain traction so you can move forward with a better sense of control.



7



8



9

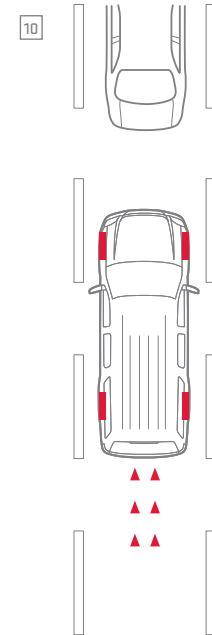

10

7 FULLY INDEPENDENT FRONT SUSPENSION The independent front suspension in Yukon uses a strong and compact coil-over-shock system for a tight turn radius and a smooth ride. The 2500 Series models use an innovative torsion bar system that gives a smooth ride with no sacrifice in capability.

8 EATON® HEAVY-DUTY AUTOMATIC LOCKING REAR DIFFERENTIAL No other competitor in its class offers this automatic locking rear differential for on- or off-road use. When the Eaton locker senses a difference in rotational speed between left and right rear wheels of approximately 100 rpm, it locks the differential to turn both wheels in unison for added traction.

HILL START BRAKE ASSIST To help you hold your place when parked on an incline, Hill Start Brake Assist senses potential “roll-back” and then holds full brake pressure when you lift your foot from the pedal. It gives you extra time to apply power and drive off. (Not available on Hybrid models.)

INTELLIGENT BRAKE ASSIST In an abrupt stop, milliseconds can be your margin of safety. Intelligent Brake Assist senses when you abruptly apply the brake pedal and applies more braking force before your foot presses the pedal all the way to improve reaction time in a panic brake situation.

MAGNETIC RIDE CONTROL For smoothness and refinement that rival premium luxury sedans, Yukon Denali Hybrid features the remarkable capability of Magnetic Ride Control. This system senses changes in the road surface up to 1000 times per second, instantly adjusting the shock absorbers for maximum comfort and control, without sacrificing agility.

POWER RACK-AND-PINION STEERING Standard on all Yukon 1500 models, this provides a positive, on-center feel at high-way speeds, as well as extra low-speed assist for maneuvering in tight spaces. Hybrid models use an electric power steering assist that eliminates the traditional hydraulic pump and connections to save weight and enhance fuel economy.¹

¹EPA-estimated 20 city/23 hwy mpg.

9 TRAILER BRAKE CONTROLLER For fingertip control and easy monitoring of your trailer brakes, Yukon offers an available integrated trailer brake controller (standard on ¾-ton models). It is located close to the steering wheel for easy adjustments and displays the level of brake force or “gain” in the Driver Information Center. (Not available on Hybrid models.)

10 ANTILOCK BRAKING SYSTEM (ABS) For confident stops in a variety of conditions, every Yukon features four-channel antilock brakes. When the brakes are applied, ABS can detect impending wheel lock-up, and then pulse that wheel’s brake to prevent it. The four-channel system can activate any combination of vehicle brakes to maintain control.

EXTERIOR

Our engineers pushed the limits of design with Yukon's exterior. The bold lines and striking looks are complemented by innovative options such as power-retractable mirrors, power-retractable assist steps and a power-operated liftgate. These options show that when limits are pushed, there's no compromise between convenience and luxury.



11 HEATED POWER-RETRACTABLE MIRRORS

Standard on Denali and Hybrid models, and available on the SLT, these mirrors are heated to remove snow, frost and fogging and feature integrated turn indicators that signal your intentions to other drivers. The driver's side mirror dims automatically to deflect glares away from your line of sight. Both mirrors fold back for extra clearance in close parking situations or to help prevent damage in automatic car washes.



12 ASSIST STEPS To give you a secure foothold for easy entry, assist steps are standard. Yukon Denali and Denali Hybrid models come standard with steps with chrome inserts. Denali models offer innovative power-retractable assist steps that extend when the door is opened and retract when closed to provide a cleaner profile. (Not available on Hybrid models.)

REMOTE POWER LIFTGATE

Loading up your Yukon with your hands full? Let us help you with that. The available power liftgate opens with a touch of your key fob for easier access to your Yukon's impressive cargo capacity. You can close it the same way, or use the switch located on the liftgate itself or on the overhead center console.

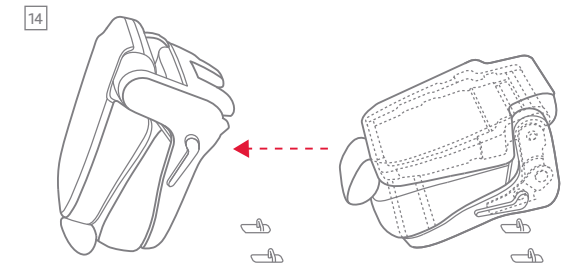
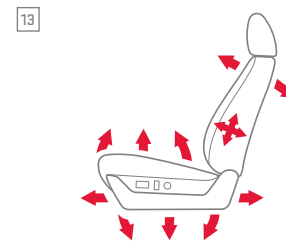



INTERIOR

Attention to interior details both large and small makes Yukon a refined traveling companion. From the easily configurable layout provided by the available power-release fold-and-tumble second-row seating to the ultra-soft feel of the optional Nuance leather-appointed seating, Yukon's interior allows you and your passengers to travel in luxurious comfort.

SEATING CONFIGURATIONS

Yukon comes standard with seating for eight, and with an available 40/20/40 front split bench, SLE models can comfortably accommodate up to nine passengers. On SLT models, second-row captain's chairs are also available. Yukon Denali comes standard with second-row captain's chairs, and with an available 60/40 second-row split-folding three-passenger bench seat, it can seat up to eight. Yukon Hybrid and Yukon Denali Hybrid both seat up to eight passengers.

13 POWER FRONT SEATING All Yukon models come standard with power-adjustable front seats. For the utmost in driver comfort, Denali models come standard with leather-appointed 12-way power heated and cooled front bucket seats with perforated inserts that circulate cooled air between you and the seating surface in warm weather. On all SLT models, in addition to the available leather-appointed 10-way power heated front bucket seats, 10-way power heated and cooled seats are also available for added comfort. SLE models come standard with 6-way power driver and front-passenger seats.

14 POWER-RELEASE FOLD-AND-TUMBLE SECOND-ROW SEATING

Power-release fold-and-tumble seats are available for the second-row bench or captain's chairs. Each seat automatically unlatches with the touch of a button, and with simple one-hand operation, folds and tumbles out of the way for easy access to the third row. (Not available on SLE or Hybrid models.)

15 PREMIUM NUANCE LEATHER-APPOINTED SEATING SURFACES

In Yukon Denali models, the ultra-soft feel of Nuance leather-appointed seating surfaces is standard in the first- and second-passenger rows to give the SUVs with the ultimate in capability the ultimate level of comfort.

TRI-ZONE CLIMATE CONTROL

The standard tri-zone climate control creates individual areas for the driver, the front-seat passenger and the rear-compartment passengers. Second-row passengers get their own controls for temperature and fan speed, so drivers can concentrate on the road.

16 POWER-ADJUSTABLE PEDALS

To help drivers of varying sizes sit at a comfortable distance from the steering wheel, adjustable pedals are available in SLE models and are standard in SLT models and Denali. On Denali and SLT-2 models, the pedals also have a memory feature that automatically recognizes your key fob and moves the pedals back to your desired settings.

HEATED STEERING WHEEL

Standard on Yukon Denali and available on SLT models, a built-in heating system warms the steering wheel rim to give you gloves-off comfort even on the coldest days.

17 STEERING-WHEEL-MOUNTED RADIO CONTROLS

Control your audio system with your fingertips as you keep your hands on the wheel. These controls adjust the radio band, channel selection, volume and muting, as well as manage the functions of your available hands-free phone service through OnStar or your mobile Bluetooth®-enabled phone.¹

¹Go to gm.com/bluetooth to see which Bluetooth phones are compatible with the vehicle.



TECHNOLOGY

Yukon's center console is your command center for staying connected. The available Touch-Screen Navigation¹ System helps keep you entertained and informed. Rear-seat entertainment options offer passengers in the back controls to enjoy the ride even more. Auxiliary input, Bluetooth^{®2} features, a 3-month trial of SiriusXM Satellite Radio³ and Bose[®] audio systems ensure every song and phone call sound like you're in the same room.

¹Map coverage for Puerto Rico and the Virgin Islands available on separate disc. Coverage not available for portions of Canada. ²Go to gm.com/bluetooth to see which Bluetooth phones are compatible with the vehicle. ³If you subscribe after your trial period, *subscriptions are continuous until you call SiriusXM to cancel*. See SiriusXM Customer Agreement for complete terms at siriusxm.com. Other fees and taxes will apply. All fees and programming subject to change. For more information about NavTraffic, visit siriusxm.com/navtraffic. For more information about Travel Link, visit siriusxm.com/travellink. XM satellite service is available only to those in the 48 contiguous USA and DC.

18

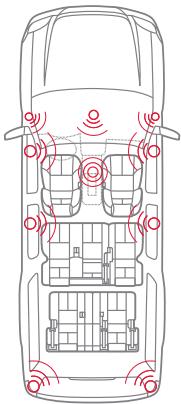

19

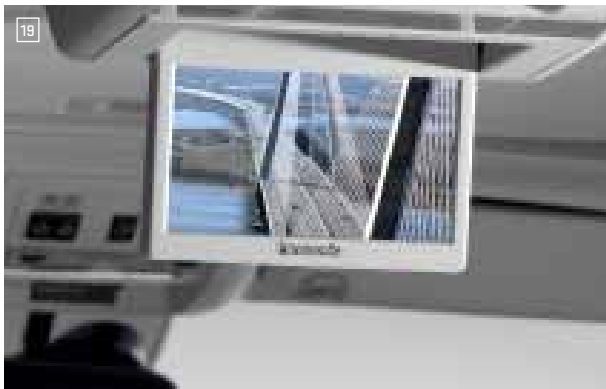

20



21



AUXILIARY INPUT CAPABILITY

Bring the music and entertainment you love to your Yukon just by plugging in a simple playback cable. Accommodates most MP3 players and devices, including iPod[®] and many smartphones.

AVAILABLE DEALER-INSTALLED WI-FI⁴

Connect up to 20 wireless users at one time and stay in touch with your life's vital information with the first wireless router designed just for automotive use. It's called Autonet Wi-Fi and it allows any combination of laptops, phones or other Wi-Fi-enabled devices to connect to the Internet, wherever you are. Ask your dealer for specific plans and prices.

⁴Monthly rates apply. Visit autonetmobile.com for coverage map and details.

BLUETOOTH FOR PHONE⁵

Extend your capabilities just by activating the available Bluetooth feature on your phone or portable device. This lets your Bluetooth device work through the controls and features already installed in your Yukon, including hands-free operation and dialing. With your Bluetooth device activated, turning the key automatically continues the conversation over the built-in hands-free phone system.

⁵Go to gm.com/bluetooth to see which Bluetooth phones are compatible with the vehicle.

BOSE AUDIO SYSTEMS

Make the front seat of your Yukon sound like the front row of your favorite concert. Bose systems are engineered to give you the

realism and presence of a live performance. Standard on SLE, SLT and Hybrid models, Bose audio features a premium speaker system with a center console-mounted woofer for rich bass tones that give you a fuller listening experience.

18 BOSE CENTERPOINT[®] SURROUND SOUND

For the sensation of a live performance while you drive, Denali models have a standard Bose Centerpoint 10-speaker surround sound system with SurroundStage[®] signal processing. This technology, along with AudioPilot[®] noise compensation, wraps you in sound, delivering five independent channels from existing two-channel recordings.

19 REAR-SEAT ENTERTAINMENT SYSTEM

Let your rear-seat passengers enjoy the ride even more. This available system includes a DVD player and 8" flip-down screen. It also comes with dual-play, which has a separate upper DVD slot in the radio to let front-seat passengers control the DVD or music playing behind them. Yukon XL and Denali XL models feature two screens, with one screen specifically for the third-row passengers. This system is compatible with most popular video gaming systems.

20 SIRIUSXM SATELLITE RADIO⁶

Enjoy SiriusXM Satellite Radio in your Yukon with a 3-month trial subscription to the XMPremier Package. Only SiriusXM brings you more of what you love, all in one place. Get over 140 channels, including commercial-free music plus the best sports, news, talk, comedy and entertainment. With NavTraffic, you'll get continuously updated traffic as it occurs, right on your vehicle's available navigation system. Welcome to the world of SiriusXM.

⁶If you subscribe after your trial period, *subscriptions are continuous until you call SiriusXM to cancel*. See SiriusXM Customer Agreement for complete terms at siriusxm.com. Other fees and taxes will apply. All fees and programming subject to change. For more information about NavTraffic, visit siriusxm.com/navtraffic. For more information about Travel Link, visit siriusxm.com/travellink. XM satellite service is available only to those in the 48 contiguous USA and DC.

21 TOUCH-SCREEN NAVIGATION⁷

For easy operation, the available system includes a large 7" in-dash touch-screen display, 2-D or 3-D map graphics and 3 months of NavTraffic. OnStar[®] subscribers can also use this system with OnStar Turn-by-Turn Navigation assistance (standard for 6 months). For your convenience, this screen also serves as a large, easily read monitor for the available Rear-Vision Camera System. Features include a pause-and-play feature for live radio broadcasts that works like a DVR for your vehicle, a built-in hard drive, an available XMWeather subscription and improved display resolution for enhanced visibility and viewing.

⁷Map coverage for Puerto Rico and the Virgin Islands available on separate disc. Coverage not available for portions of Canada. ⁸Visit onstar.com for coverage map, details and system limitations.

ONSTAR¹¹

OnStar lets you speak to an OnStar Advisor just by pressing the blue button on your rearview mirror. They can guide you anywhere or suggest nearby points of interest. If you have the navigation system installed, directions can be downloaded directly to your navigation screen.

¹¹Visit onstar.com for coverage map, details and system limitations.



22 USB CONNECTIVITY⁹ Plug into the standard USB port and you can control most of your iPod[®] or MP3 music player's functions, including playlists and song selection, from your convenient steering-wheel-mounted radio controls.

⁹Not compatible with all devices.

22 REAR-VISION CAMERA SYSTEM

Make it easier to back up to a trailer or negotiate a tight space. This available system (standard in Denali and SLT models) places a monitor in your rearview mirror or navigation screen (if equipped) to display a view of the area behind the vehicle. The Rear-Vision Camera System does not replace driver vision. Please use proper care when backing up.

23 REMOTE VEHICLE START

This available feature will start and run your Yukon for up to 10 minutes from up to 195 feet

away. If your Yukon is equipped with automatic climate control, it will default to heating or cooling mode based on the outside temperature.

ULTRASONIC REAR PARKING ASSIST

This feature sends out ultrasonic waves that alert you to certain stationary objects up to 8 feet behind the vehicle. Available on SLE and standard on all other Yukon models, the system operates at 5 mph or less. The closer you are to an object, the faster it beeps, to give you a clear signal that can help you operate the vehicle with maximum care.

UNIVERSAL HOME REMOTE

Never get locked out again. This available remote can be easily programmed to operate the majority of garage-door-opening systems and has the added benefit of never needing batteries.



ONSTAR VEHICLE DIAGNOSTICS¹⁰

(OVD) The peace of mind that comes from knowing the condition of your Yukon's key systems is as easy as checking your e-mail. OnStar Vehicle Diagnostics is a service that is standard with your 6-month trial subscription to the Directions & Connections Plan and can run hundreds of checks of your Yukon's engine, transmission, antilock brakes and more, then organize the information in an easy-to-read monthly report. OnStar can also run a check of your vehicle as you drive; just press the blue button and ask the Advisor for an On-Demand Diagnostics check. That's peace of mind when you need it.

¹⁰Capabilities vary by model. Visit onstar.com for details and system limitations.

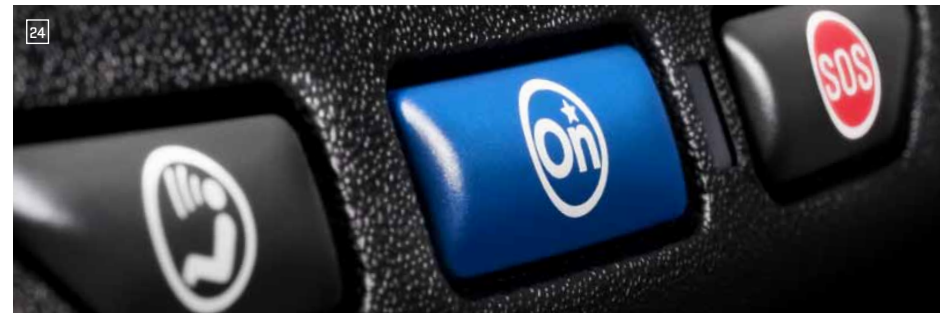

24 DIRECTIONS & CONNECTIONS PLAN¹²

Non-stop communication and never-ending demands on your time place a premium on the ability to sort and focus on the information of greatest importance to you. To place this capability at your fingertips, every Yukon has a 6-month trial subscription to the OnStar Directions & Connections Plan, standard.

¹²Visit onstar.com for coverage map, details and system limitations.

HANDS-FREE CALLING¹³ WITH VOICE-ACTIVATED DIALING

Available OnStar Hands-Free Calling is built into your Yukon. Just push the voice command button, call out the number and you're free to keep your eyes on the road. It's reliable, because it is specially designed for better connectivity and fewer dropped calls in areas with limited cellular reception.

¹³Visit onstar.com for coverage map, details and system limitations.

TURN-BY-TURN NAVIGATION

Drive with more confidence and certainty. OnStar Turn-By-Turn Navigation is built into your Yukon. It's simple—all you have to do is push one button and ask the OnStar Advisor to download directions to your Yukon. Turn-By-Turn is also smart, because an automated voice calls out every turn, as you need it.

ONSTAR eNAV¹⁴ WITH MAPQUEST.COMTM

Want to get a head start on a trip? Start by checking out your destination on mapquest.com. With OnStar eNav, just click the "Send" link on the Web site, and it will be sent to your vehicle. When you're ready to head out, simply retrieve the destination and directions will be downloaded to your vehicle based on your location, with nothing to type on the screen and no maps to hold.

¹⁴Requires Directions & Connections Plan. Visit onstar.com for coverage map. Services vary by model.

DESTINATION DOWNLOAD

Looking for a destination in your vehicle's screen-based navigation system? OnStar will do it for you. Simply press your blue OnStar button, and you will be connected with a trained Advisor who will download your directions to your Yukon's screen-based navigation system. You can also have destinations downloaded on the go—no need to pull over to enter new addresses. It's an enhancement to navigation that makes screen-based navigation systems easier and faster to use.

ONSTAR SAFETY¹

OnStar provides peace of mind through technology. Live OnStar Advisors can provide services as critical as notifying authorities when an accident occurs, as helpful as dispatching roadside assistance on your behalf, or as important as remotely unlocking your vehicle if you're locked out. Your safety is paramount, so we created the OnStar RemoteLink app², which puts similar functions in the palm of your hand.

¹Visit onstar.com for coverage map, details and system limitations. OnStar acts as a link to existing emergency service providers. Services vary by model and with conditions. ²Available on iPhone,[®] select Android[™] and Blackberry[®] platforms. Services vary by phone, vehicle and conditions.

25 AUTOMATIC CRASH RESPONSE

In most crashes, built-in sensors can automatically send an alert to OnStar. An OnStar Advisor is immediately connected to your vehicle to help you. Even if you aren't capable of responding, the Advisor can use GPS technology to locate you and request that emergency help is sent right away.

26 **CRISIS ASSIST** During severe weather or other natural disasters, OnStar can offer assistance and help you navigate your way to safety. Just push the red SOS button and our Crisis Assist Team moves quickly to help you. OnStar can pinpoint your location and provide up-to-date information from public safety authorities, request that help be sent to you or even contact family members or loved ones.

26 **EMERGENCY SERVICES** If someone in or around your Yukon needs emergency help, the red SOS button gives you a priority connection to a specially trained Advisor at any time, day or night. OnStar uses GPS technology to pinpoint your location and can request police, fire or medical support be sent right away. The Advisor can also stay with you until help arrives.



27 STOLEN VEHICLE ASSISTANCE

If your Yukon is ever stolen, OnStar can help to locate it after verification with law enforcement. OnStar can use built-in GPS technology to help locate it, prevent it from restarting with Remote Ignition Block or, if the vehicle is in use, engage the Stolen Vehicle Slowdown technology to help police recover it quickly and safely.

27 **ROADSIDE ASSISTANCE³** If the unexpected happens on the road—you're stranded, run out of gas or have a flat tire—one push of the blue OnStar button can immediately connect you to an Advisor, ready to help any hour of the day or night. OnStar can use GPS technology to pinpoint your exact location and direct a service provider to you. No guessing about where you are or what to do.

³Roadside service provided by Cross Country.

28 **REMOTE DOOR UNLOCK** It's happened to everyone. But there is an easy solution. If you get locked out of your Yukon, OnStar can help. After verifying your account, an OnStar Advisor can send a remote signal to your Yukon that usually unlocks the doors within minutes.

REMOTE HORN AND LIGHTS Say you're in a large parking area and you just can't remember where you parked. Just call the toll-free number and OnStar can send a remote signal to flash your lights and sound your horn to help you locate your Yukon.

29 **ONSTAR REMOTELINK APP⁴** The OnStar RemoteLink mobile app offers an amazing level of control and connection with your vehicle. After downloading and registering the app, GMC owners with an eligible vehicle can use their iPhone,[®] Android[™] or Blackberry[®]-based smartphone to control the vehicle and perform specific commands—like unlocking doors, starting the vehicle remotely, flashing lights

and sounding the horn to help locate the vehicle or contacting an OnStar Advisor, Roadside Assistance or their preferred dealer. To learn all about all the great features available, go to onstar.com.

⁴Available on iPhone,[®] select Android[™] and Blackberry[®] platforms. Services vary by phone, vehicle and conditions.

SAFETY

The 2013 Yukon has received a 5-Star Overall Frontal Crash and 5-Star Overall Side Crash Safety Rating.⁵ With head curtain side-impact air bags⁶ that reach from the front to third row of seating for outboard passengers, Yukon is engineered to help protect passengers regardless of where they're seated. The LATCH child seat anchoring system helps you to properly secure child seats. Antilock brakes, tire pressure monitoring and StabiliTrak stability control system work to help enhance your safety during every trip.

⁵Government 5-Star Safety Ratings are part of the National Highway Traffic Safety Administration's (NHTSA's) New Car Assessment Program (safercar.gov). ⁶Air bag inflation can cause severe injury or death to anyone too close to the air bag when it deploys. Be sure every occupant is properly restrained. Always use safety belts and the correct restraint for your child's age and size, even with air bags. Even in vehicles equipped with the Passenger Sensing System, children are safer when properly secured in a rear seat in the appropriate infant, child or booster seat. Never place a rear-facing infant restraint in the front seat of any vehicle equipped with an active frontal air bag. See your vehicle Owner's Manual and child safety seat instructions for more safety information.



30 SAFETY CAGE CONSTRUCTION Yukon's safety cage, consisting of reinforcements in the A-pillar and roof rail and bracing under the driver and passenger floor area, helps maintain the integrity of the passenger compartment in the event of a collision.

31 PASSENGER COMPARTMENT AIR BAGS⁷ Yukon's passenger compartment is equipped with six air bags to reduce the risk of injury. Dual-stage frontal air bags have sensors that gauge crash severity and determine whether to deploy one or two levels of inflation. A Passenger

Sensing System automatically disables the passenger air bag if the passenger is under the appropriate weight. Side-impact air bags provide thorax and pelvic protection for outboard front-seat occupants. Standard head curtain side-impact air bags, located in the ceiling above the side windows, are designed to protect the first-, second- and third-row outboard passengers in the event of a side-impact or rollover collision.

⁷Air bag inflation can cause severe injury or death to anyone too close to the air bag when it deploys. Be sure every occupant is properly restrained. Always use safety belts and the correct restraint for your child's age and size,

even with air bags. Even in vehicles equipped with the Passenger Sensing System, children are safer when properly secured in a rear seat in the appropriate infant, child or booster seat. Never place a rear-facing infant restraint in the front seat of any vehicle equipped with an active frontal air bag. See your vehicle Owner's Manual and child safety seat instructions for more safety information.

LATCH CHILD SEAT ANCHORING SYSTEM LATCH (Lower Anchors and Top tethers for Children) equipped child seats will install to specially designed retainer hooks in your Yukon. LATCH also enables the attachment of a child seat top tether strap that helps limit movement in a forward crash to help reduce the chance of injury,

PASS-KEY III THEFT DETERRENT SYSTEM A tiny chip in your ignition key prevents unauthorized starting attempts in your Yukon. It functions as an electronic "fingerprint" that disables your starting system if it detects a theft is underway.

SIDE BLIND ZONE ALERT⁸ This feature alerts you to other vehicles in your Yukon's blind zones. It's standard on Denali and available on SLT. Alternating radar beams sweep adjacent traffic lanes, covering a zone approximately one lane over

from each side of the vehicle. A dedicated amber icon next to the outside rearview mirror's turn-signal display lights up any time there is a vehicle in the blind spot and flashes if you activate the turn signal.

⁸Before making a lane change, always check the Side Blind Zone Alert display, check the side and inside rearview mirrors, look over your shoulder for vehicles and hazards and start the turn signal.

TIRE PRESSURE MONITORING SYSTEM Properly inflated tires are important to your comfort, vehicle control and fuel economy. This system uses tiny sensors

inside the wheel to "broadcast" tire pressure to your vehicle,⁹ which alerts you to their status and inflation level through the Driver Information Center. If you subscribe to OnStar Vehicle Diagnostics, this information is part of their monthly e-mail update, or if you have the OnStar RemoteLink app, you can check the status.

⁹Does not monitor spare tire.

EXTERIOR COLORS

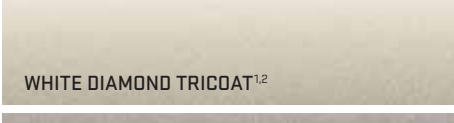
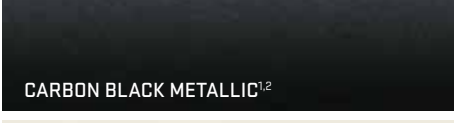
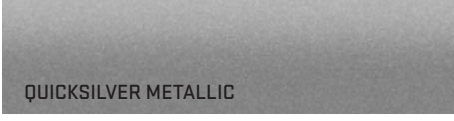

All colors are basecoat/clearcoat for high gloss and durable finish. See dealer for more details on paint and color availability. ¹Extra-cost color. ²Not available on Yukon Hybrid.





YUKON DENALI IN ONYX BLACK shown with available equipment.

WHEELS

YUKON



N88 17" POLISHED ALUMINUM
STANDARD: SLE AND SLT
1500 MODELS ONLY



RDP 20" POLISHED ALUMINUM
AVAILABLE: SLE AND SLT
1500 MODELS ONLY



S86 20" CHROME-CLAD ALUMINUM
AVAILABLE: SLE AND SLT
1500 MODELS ONLY

YUKON DENALI



P41 20" CHROME WHEEL
STANDARD: YUKON DENALI AND
YUKON XL DENALI

YUKON HYBRID



P71 18" BRIGHT MACHINED FINISH
STANDARD AND ONLY AVAILABLE
ON YUKON HYBRID



RVA 22" 8-SPOKE CHROME
STANDARD AND ONLY AVAILABLE
ON YUKON DENALI HYBRID

YUKON 3/4-TON



P25 17" WITH 8 LUGS MACHINED ALUMINUM
STANDARD: YUKON XL 2500 MODELS ONLY



YUKON SLT INTERIOR IN LIGHT TITANIUM shown with available equipment.

INTERIOR COLORS

PREMIUM CLOTH Standard on SLE

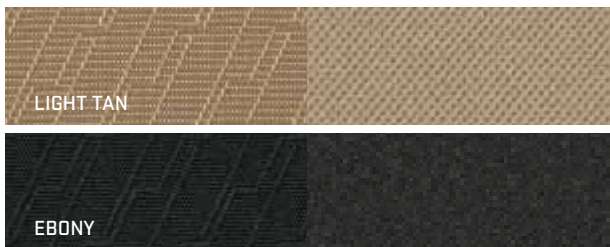

LEATHER-APPOINTED Standard on SLT and Hybrid

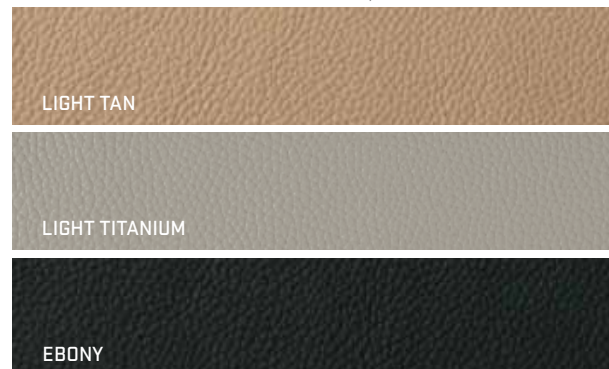

PERFORATED LEATHER-APPOINTED Standard on Denali, available on SLT



¹Light Tan on SLT. ²Not available on Denali.

ACCESSORIES

GMC Accessories are engineered and tested to meet the standards of your Yukon. Available individually or as part of a complete package, they are the easiest way to customize your Yukon while still keeping it Professional Grade. Customizing your Yukon is easy, just ask your dealer.



ACCESSORY WHEELS³

Roll with the best. These custom wheels feature a brilliant, durable chrome or two-tone black gloss and polished finish, and are available with matching lugs and GMC center caps.



CK951 20"
CHROME (VSA)



CK945 20"
CHROME (VSD)



CK370 20"
CHROME (VZK)



CK997 20"
CHROME (VSF)



CK948 20"
CHROME (VSB)



CK916 22"
CHROME (VSK)



CK910 22"
CHROME (SES)



CK375 22"
CHROME (VSJ)



CK366 22"
CHROME (VSA)



CK798 22"
BLACK
POLISHED (VSN)

³Use only GM-approved tire and wheel combinations. Unapproved combinations may change the vehicle's performance characteristics. For approved tire and wheel combinations and other important information, go to gmaccessorieszone.com or see your dealer for details.



CHROME GRILLE Specifically designed and engineered for your vehicle, this grille has a chrome surround and features the GMC logo.



TRAILER HITCH CLOSEOUT This custom-molded cover hides the trailer hitch receiver when not in use. Available in select body colors. Not available for Yukon Denali or Yukon XL Denali.



CHROME ASSIST STEPS Make it easier to get in and out of your Yukon with these stylish assist steps. Crafted from rust-resistant stainless steel, they come as 6" oval chrome steps.

TRIM LEVELS

MECHANICAL

	SLE	SLT	DENALI	HYBRID	DENALI HYBRID
ALTERNATOR 160-amp. Requires Snow Plow Prep Package on ¾-ton models. 145-amp, ¾-ton models	●	●	●	—	—
BATTERY Heavy-duty maintenance-free with 730 cold-cranking amps and rundown protection Battery Pack 300-volt hybrid, located under second-row seat cushion	—	—	—	●	●
BRAKES 4-wheel Antilock Brake System (ABS), 4-wheel disc	●	●	●	●	●
DRIVETRAIN 2WD 4WD. Single-speed active transfer case. 4WD. Active 2-speed transfer case with rotary controls. Included with Heavy-Duty Trailing Package. All-Wheel Drive (AWD). Electronic automatic system; includes AWD transfer case.	●	●	●	●	●
ENGINES Vortec 5.3L V-8 VVT FlexFuel with Active Fuel Management, E85 capable Vortec 6.0L V-8 VVT Hybrid with Active Fuel Management Vortec 6.0L V-8 VVT, requires ¾-ton models Vortec 6.2L V-8 VVT with Active Fuel Management, E85 capable	●	●	—	—	—
ENGINE BLOCK HEATER	○	○	○	—	—
EXTERNAL ENGINE OIL COOLER Heavy-duty air-to-oil, integral to radiator. Requires Heavy-Duty Trailing Package on ½-ton Yukon and XL models. Standard on ¾-ton models.	○	○	●	—	—
HEAVY-DUTY AUTOMATIC LOCKING REAR DIFFERENTIAL	●	●	●	●	●
HIGH-VOLTAGE MANAGEMENT Power electronics module	—	—	—	●	●
REGENERATIVE BRAKING	—	—	—	●	●
STABILITRAK Stability control system and traction control. Includes trailer sway control and Hill Start Brake Assist. (Not available on Hybrid models.)	●	●	●	●	●
STEERING Power. On Hybrid models, includes 42-volt electric power.	●	●	●	●	●
SUSPENSION Front independent coil-over-shock with stabilizer bar. ½-ton models only. Front independent with torsion bar. ¾-ton models only. Rear multilink with coil springs. Leaf springs on ¾-ton models. Automatic Rear Level Control, air. ½-ton models only. Magnetic Ride Control, road sensing, electronically controlled shock absorbers Premium Smooth Ride Suspension AutoRide Suspension Package. Bi-state variable shock dampening and rear air-assisted load-leveling, includes automatic air-level control. Not available on ¾-ton models. Z71 Off-Road Suspension Package. Available only on Yukon SLE and SLT 4WD and ½-ton XL 4WD models. Includes Skid Plate Package, P265/70R17 on-/off-road, blackwall tires and high-capacity air cleaner on all models. Not available with SLT Chrome Package.	●	●	●	●	●
TRAILERING Trailer Brake Controller, integrated. On SLE and SLT, requires Heavy-Duty Trailing Package. Standard on ¾-ton models. Trailing Equipment. Includes hitch platform with 2" trailing receiver and 7-wire harness with independent fused trailing circuits mated to a 7-way sealed connector.	○	○	○	—	—
TRANSMISSION 6-speed automatic, heavy-duty, electronically controlled with overdrive, Tow/Haul mode, Electronic Engine Grade Braking and tap up/tap down shifting 2-mode strong hybrid automatic electronic with Tow/Haul mode built in to the software	●	●	●	—	—

PACKAGES

CONVENIENCE PACKAGE Includes power-adjustable pedals, remote vehicle start, Rear Parking Assist, inside rearview mirror with rear camera display and Rear-Vision Camera System	○	—	—	—	—
HEAVY-DUTY TRAILERING PACKAGE Includes auxiliary external transmission oil cooler, external engine oil cooler, power steering cooler and increased-capacity radiator and cooling fans. Includes 3.42 rear axle ratio. Not available on ¾-ton models. Includes 2-speed AutoTrac on 4WD models. Heavy-Duty Handling/Trailing Suspension. ¾-ton models only.	○	○	●	—	—
REGIONAL VALUE PACKAGE Includes outside heated power-adjustable, power-folding and driver-side auto-dimming mirrors, 1 year of SiriusXM Satellite Radio service, ¹ 20" polished aluminum wheels, Heavy-Duty Trailing Package, chrome door handles, chrome mirror caps, polished exhaust tip [dealer installed], chrome recovery hooks and chrome grille [dealer installed]. Not available with Sun, Entertainment & Destination Package or 20" chrome-clad wheels.	●	●	—	—	—
SKID PLATE PACKAGE Includes front underbody shield. Requires 4WD models and Z71 Off-Road Suspension Package. Standard on ¾-ton models.	○	○	—	—	—

TRIM LEVELS

PACKAGES, cont.

	SLE	SLT	DENALI	HYBRID	DENALI HYBRID
SLT CHROME PACKAGE Includes chrome door handles, chrome mirror caps, polished exhaust tip, chrome recovery hooks, chrome grille, outside heated power-adjustable, power-folding and driver-side auto-dimming body-color mirrors and 20" polished aluminum wheels. Not available with Z71 Off-Road Suspension Package.	—	○	—	—	—
SLT-2 EQUIPMENT PACKAGE Includes 10-way power leather-appointed heated front bucket seats, heated second-row seats, second-row power seat release, rear power liftgate and outside heated power-adjustable, power-folding mirrors with memory feature. Includes heated, leather-wrapped steering wheel with ½-ton models.	—	○	—	—	—
SNOW PLOW PREP PACKAGE Includes instrument panel switch, roof beacon wiring, forward lamp wiring and torsion bar [¾-ton models only]	○	○	—	—	—
SUN, ENTERTAINMENT & DESTINATION PACKAGE Includes 1 year of SiriusXM Radio ¹ and NavTraffic service, power sunroof, inside rearview auto-dimming mirror, audio system with navigation and Rear-Seat Entertainment System. On SLT models, not available with AM/FM stereo with CD player and MP3 playback, or audio system with Rear-Seat Entertainment System.	—	○	○	—	—
TEXAS EDITION Includes Regional Value Package features plus Texas Edition badge	—	○	—	—	—
SEATING					
SEATS 40/20/40 front split-bench, 3-passenger with Premium Cloth. Includes 6-way power driver seat adjuster, driver and front-passenger manual reclining, center fold-down armrest with storage, lockable storage compartments in seat cushion (includes auxiliary power outlet), outboard adjustable head restraints and storage pockets. Front buckets. Includes 6-way power driver and passenger seat adjuster, outboard adjustable head restraints, floor console and rear storage pockets. Premium Cloth on SLE models. Leather-appointed first and second row with heated front seat cushion and seatbacks on SLT and Hybrid. Leather-appointed seats on the first and second rows. Includes front bucket seats with 10-way power driver and front-passenger seat adjusters, including power lumbar control, heated seat cushion and seatbacks, 2-position driver memory, adjustable head restraints, storage pockets and floor console. Requires SLT-2 Equipment Package. Heated and cooled perforated leather-appointed seats on first row and heated perforated leather-appointed seats on second row. Includes front bucket seats with 10-way power driver and front-passenger seat adjusters (12-way on Denali models), including power lumbar control, heated and cooled seat cushions and seatbacks, 2-position driver memory, adjustable head restraints, storage pockets and floor console. SLT models require SLT-2 Equipment Package. 60/40 second-row split-folding 3-passenger bench in Premium Cloth, with center armrest and storage tray 60/40 second-row split-folding 3-passenger leather-appointed bench with center armrest and storage tray Leather-appointed second-row reclining captain's chairs. On Denali, includes heated cushions. Heated second-row seat cushions. On bench seating, outboard positions only. Fold-and-tumble power second-row seat release for captain's chairs or bench seat. Requires front bucket seats with leather-appointed seating surfaces. 50/50 third-row split-bench seats, 3-passenger, removable, all belts-to-seat	○	—	—	—	—
	●	●	—	●	—
	—	○	—	—	—
	—	○	●	—	●
	—	○	●	—	—
	●	●	●	●	●

INSTRUMENTATION AND CONTROLS

INSTRUMENTATION Analog cluster with speedometer, odometer/trip odometer, fuel level, voltmeter, engine temperature, oil pressure and tachometer. Driver Information Center including temperature and compass. Hybrid models include efficiency gauge.	●	●	●	●	●
POWER-ADJUSTABLE PEDALS On SLE models, included and only available with Convenience Package	○	●	●	●	●
REAR-VISION CAMERA SYSTEM With auto-dimming inside rearview mirror display. SLE models require Convenience Package. With NAV-screen display. Requires Touch-Screen Navigation.	○	●	—	—	—
STEERING WHEEL Leather-wrapped, with controls for audio, cruise control and Bluetooth-enabled ² phone, plus tilt-adjustable column with brake/transmission shift interlock. Deluxe leather-wrapped with power-tilt on Denali and Denali Hybrid. Heated steering wheel	—	○	●	—	—
TOW/HAUL MODE SELECTOR Built-in automatic on Hybrid models	●	●	●	●	●
ULTRASONIC REAR PARKING ASSIST With audible warning. On SLE models, included and only available with Convenience Package.	○	●	●	●	●

TRIM LEVELS

INTERIOR DETAILS AND CONVENIENCE FEATURES

	SLE	SLT	DENALI	HYBRID	DENALI HYBRID
CARPET Color-keyed with removable carpeted floor mats for first and second rows	●	●	●	●	●
CLIMATE CONTROL Tri-zone manual air conditioning. Available on SLE models with bench seat.	○	–	–	–	–
Tri-zone automatic air conditioning, includes individual climate settings for driver and right-front passenger. On SLE, not available with optional 40/20/40 front split-bench seating.	●	●	●	●	●
Rear auxiliary heater and air conditioner with rear-passenger heating and air ducts	●	●	●	●	●
Defogger, rear-window electric	●	●	●	●	●
CONSOLES Overhead mini with map lights	●	●	●	●	●
Floor with storage area, cupholders and integrated second-row audio and HVAC controls. Included and only available with front bucket seats.	●	●	●	●	●
Storage bin behind driver-side rear quarter panel	●	●	●	●	●
CUPHOLDERS Front seating area, rear floor console, third-row outboard side trim	●	●	●	●	●
MIRROR Auto-dimming rearview	●	●	●	●	●
OUTLETS 12-volt power, 5 (3 with bench seat)	●	●	●	●	●
PADDED VISORS AND ARMRESTS	●	●	●	●	●
POWER PROGRAMMABLE DOOR LOCKS	●	●	●	●	●
POWER WINDOWS With driver express-down and lockout protection	●	●	●	●	●
REMOTE STARTER SYSTEM With keyless entry. On SLE models, requires Convenience Package.	○	●	●	●	●
SUNROOF Power, tilt-sliding with express-open and -close and wind deflector. On SLE, not available with optional 40/20/40 front split-bench seating.	○	○	○	○	○
UNIVERSAL HOME REMOTE Includes programmable garage door opener. Deleted on XL models when Snow Plow Prep Package is ordered.	–	●	●	●	●

ENTERTAINMENT/COMMUNICATION/NAVIGATION

AUDIO SYSTEM AM/FM stereo with CD player and MP3 playback, seek-and-scan, digital clock, auto-tone control, Radio Data System (RDS), ³ speed-compensated volume, TheftLock, auxiliary input jack and USB port ⁴	●	●	–	–	–
TOUCH-SCREEN NAVIGATION ⁵ AM/FM/SiriusXM ¹ stereo with CD/DVD player and MP3/WMA playback, color touch-screen display, enhanced HDD-based navigation with voice recognition, hard drive with memory available for music storage, USB port, ⁴ RDS ³ and pause/play radio	–	○	●	●	●
REAR-SEAT ENTERTAINMENT SYSTEM Includes DVD player with remote control, overhead display, 2 sets of 2-channel wireless infrared headphones and auxiliary audio/video input jacks. Requires AM/FM stereo with MP3-compatible CD/DVD player or AM/FM stereo with MP3-compatible CD/DVD player and Touch-Screen Navigation. ⁵	○	○	○	○	○
REAR AUDIO SYSTEM CONTROLS With 2 headphone jacks (headphones not included), power outlet and controls for volume, station selection and media	●	●	●	●	●
AUDIO 6-speaker system included with bench seat	○	–	–	–	–
9-speaker Bose [®] sound system with subwoofer in center console. Not available with optional front bench seat.	●	●	–	●	–
10-speaker Bose Centerpoint [®] surround sound system	–	–	●	–	●
DUAL-SCREEN ENTERTAINMENT SYSTEM Adds second screen for third-row passengers. Includes 2 additional sets of headphones. Included and only available with Rear-Seat Entertainment System. Available on XL models only.	–	○	○	–	–
ONSTAR 6 months of Directions & Connections Plan ⁶	●	●	●	●	●
SiriusXM SATELLITE RADIO ¹ 3 trial months included	●	●	●	●	●
NAVTRAFFIC ⁷ 3 trial months included. 3 years included on Hybrid models. Included and only available with Touch-Screen Navigation.	–	○	●	●	●
BLUETOOTH[®] FOR PHONE ² Personal cell-phone connectivity	●	●	●	●	●

TRIM LEVELS

EXTERIOR STYLING AND FUNCTIONALITY

	SLE	SLT	DENALI	HYBRID	DENALI HYBRID
ASSIST STEPS Black	●	●	–	●	–
Black with chrome inserts	–	–	●	–	●
Power-retractable	–	–	○	–	–
GLASS Solar-Ray deep-tinted. All windows except light-tinted glass on windshield and driver- and front-passenger-side glass.	●	●	●	●	●
LIGHTS Dual halogen composite headlamps with automatic exterior lamp control and flash-to-pass	●	●	●	●	●
Halogen front fog lamps, round. Standard on 1/2-ton SLE models. Requires available SLE Appearance Package on 3/4-ton models.	●	●	●	●	●
LUGGAGE RACK Roof-mounted side rails, black; body-color with bright accent on Yukon Denali and Denali Hybrid models	●	●	●	–	●
LUGGAGE RACK CENTER RAILS Standard on 1/2-ton SLE models. Requires available SLE Appearance Package on 3/4-ton models.	●	●	●	–	●
OUTSIDE MIRRORS Heated, power-adjustable, manual-folding, body-color	●	●	–	–	–
Heated power-folding, power-adjustable, driver-side auto-dimming, body-color mirrors with integrated turn-signal indicators, ground illumination and curb-tilt. On SLT models, requires SLT-2 Equipment Package.	–	○	●	●	●
Vertical camper, heated, power-adjustable, manual-folding, includes integrated turn-signal indicators (3/4-ton models only)	○	○	–	–	–
POWER LIFTGATE On SLT models, requires SLT-2 Equipment Package. Not available with Snow Plow Prep Package on XL models.	–	○	●	–	●
RECOVERY HOOKS 2 front, frame-mounted	●	●	●	–	●
WIPERS Front intermittent wet-arm with flat blade and pulse washers	●	●	●	●	●
Rear intermittent with washer	●	●	●	●	●

SAFETY AND SECURITY

AIR BAGS ⁷ Dual-stage frontal with Passenger Sensing System	●	●	●	●	●
Front and rear head curtain side-impact air bags for all outboard seating positions with rollover sensor	●	●	●	●	●
Front-seat-mounted side-impact driver and right front-passenger air bags for thorax and pelvis protection	●	●	●	●	●
SIDE BLIND ZONE ALERT On SLT 1/2-ton models only, requires SLT-2 Equipment Package	–	○	●	–	●
TIRE PRESSURE MONITORING SYSTEM (Does not monitor spare)	●	●	●	●	●
VEHICLE THEFT-DETERRENCE SYSTEM PASS-Key III	●	●	●	●	●

¹If you subscribe after your trial period, *subscriptions are continuous until you call SiriusXM to cancel.* See SiriusXM Customer Agreement for complete terms at siriusxm.com. Other fees and taxes will apply. All fees and programming subject to change. For more information about NavTraffic, visit siriusxm.com/navtraffic. For more information about Travel Link, visit siriusxm.com/travellink. XM satellite service is available only to those in the 48 contiguous USA and DC. ²Go to gm.com/bluetooth to find out which Bluetooth phones are compatible with the vehicle. ³RDS functions only where stations broadcast RDS information. ⁴Not compatible with all devices. ⁵Map coverage for Puerto Rico and the Virgin Islands available on separate disc. Coverage not available for portions of Canada. ⁶Visit onstar.com for details and system limitations. ⁷Always use safety belts and the correct restraint for your child's age and size, even with air bags. Even in vehicles equipped with the Passenger Sensing System, children are safer when properly secured in a rear seat in the appropriate infant, child or booster seat. Never place a rear-facing infant restraint in the front seat of any vehicle equipped with a passenger air bag. See your vehicle Owner's Manual and child safety seat instructions for more safety information.

YUKON/YUKON XL/YUKON DENALI/YUKON XL DENALI/ENGINE SPECIFICATIONS

	LMG	LC9	L96	L94	LZ1 HYBRID
ENGINE	VORTEC 5.3L V-8 VVT	VORTEC 5.3L V-8 VVT	VORTEC 6.0L V-8 VVT	VORTEC 6.2L V-8 VVT	VORTEC 6.0L V-8
HP@RPM	SWB: 320@5400 LWB: 320@5400	— LWB: 320@5400	— LWB: 352@5400	SWB: 403@5700 LWB: 403@5700	SWB: 332@5100 —
LB-FT TORQUE@RPM	SWB: 335@4000 LWB: 335@4000	— LWB: 335@4000	— LWB: 382@4200	SWB: 417@4300 LWB: 417@4300	SWB: 367@4100 —
ACTIVE FUEL MANAGEMENT	Included	Included	—	Included	Included
E85 CAPABLE	Included	Included	—	Included	—
EPA-ESTIMATED CITY/HWY MPG	15/21 GAS 11/16 E85	15/21 GAS 11/16 E85	10/16 GAS (2WD) 10/15 GAS (4WD)	14/18 GAS (2WD) 10/15 E85 (2WD) 13/18 GAS (AWD) 10/14 E85 (AWD)	20/23 GAS
STANDARD	YUKON YUKON XL 2WD	YUKON XL 4WD	YUKON XL ¾-TON	YUKON DENALI YUKON XL DENALI	YUKON HYBRID YUKON DENALI HYBRID

MEASUREMENTS/CAPACITIES

	2WD	4WD	2WD	4WD	YUKON DENALI	YUKON XL DENALI
	YUKON	YUKON	YUKON XL ½-TON / ¾-TON	YUKON XL ½-TON / ¾-TON		
TURNING DIAMETER curb to curb, ft.	39.0	39.0	43.0 / 45.3	43.0 / 45.3	39.0	43.0
WHEELBASE in.	116.0	116.0	130.0	130.0	116.0	130.0
MAXIMUM CARGO VOLUME ¹ cu.ft.	108.9	108.9	137.4	137.4	108.9	137.4
OVERALL LENGTH in.	202.0	202.0	222.4	222.4	202.0	222.4
OVERALL WIDTH in.	79.0	79.0	79.1	79.1	79.0	79.1
HEIGHT in.	76.9	76.9	76.8	76.8	77.0	77.1
FUEL TANK CAPACITY approx. gallons	26.0 (25.0 Hybrid)	26.0 (25.0 Hybrid)	31.0 / 39.0	31.0 / 39.0	26.0 (25.0 Hybrid)	31.0

YUKON/YUKON XL/YUKON DENALI/YUKON XL DENALI/TRANSMISSION SPECIFICATIONS

MODEL	DRIVETRAIN / TRANSMISSION
YUKON /YUKON XL ½-TON	2WD or 4WD / Hydra-Matic 6-speed electronically controlled automatic with Driver Shift Control, Electronic Engine Grade Braking and Tow / Haul mode
YUKON /YUKON XL ¾-TON	2WD or 4WD / Hydra-Matic 6-speed electronically controlled automatic with Driver Shift Control, Electronic Engine Grade Braking and Tow / Haul mode
YUKON DENALI	2WD or AWD / Hydra-Matic 6-speed electronically controlled automatic with Driver Shift Control, Electronic Engine Grade Braking and Tow / Haul mode
YUKON HYBRID	2WD or 4WD / Electronically controlled automatic with Driver Shift Control and built-in Tow/Haul mode
YUKON DENALI HYBRID	2WD or 4WD / Electronically controlled automatic with Driver Shift Control and built-in Tow/Haul mode

MAXIMUM TRAILER WEIGHT RATINGS²

MODEL	YUKON		YUKON XL		YUKON XL		YUKON DENALI/ YUKON XL DENALI		YUKON HYBRID/ YUKON DENALI HYBRID	
	VORTEC 5.3L		VORTEC 5.3L		VORTEC 6.0L		VORTEC 6.2L		VORTEC 6.0L HYBRID	
	AXLE RATIO	MAX. TRAILER WEIGHT LBS	AXLE RATIO	MAX. TRAILER WEIGHT LBS	AXLE RATIO	MAX. TRAILER WEIGHT LBS	AXLE RATIO	MAX. TRAILER WEIGHT LBS	AXLE RATIO	MAX. TRAILER WEIGHT LBS
1500 2WD	3.08/3.42	5500/8500	3.08/3.42	5100/8100	—	—	—	—	—	—
1500 4WD	3.08/3.42	5200/8200	3.08/3.42	5000/8000	—	—	—	—	—	—
2500 2WD	—	—	—	—	3.73	9600	—	—	—	—
2500 4WD	—	—	—	—	3.73	9400	—	—	—	—
DENALI 2WD	—	—	—	—	—	—	3.42	8300/7900	—	—
DENALI AWD	—	—	—	—	—	—	3.42	8100/7800	—	—
YUKON HYBRID 2WD/4WD	—	—	—	—	—	—	—	—	3.08/3.08	6200/5900
YUKON DENALI HYBRID 2WD/4WD	—	—	—	—	—	—	—	—	3.08/3.08	6000/5700

¹Cargo and load capacity limited by weight and distribution. ²Maximum trailer weight ratings are calculated assuming a base vehicle, except for any option(s) necessary to achieve the rating, plus driver. The weight of other optional equipment, passengers and cargo will reduce the maximum trailer weight your vehicle can tow. See your dealer for details.

IMPORTANT WORDS

COMMITMENT PLUS

From the owner orientation – and full tank of gas – you receive when you take possession of your Yukon to the **24-Hour Roadside Assistance**, **Courtesy Transportation** and **Travel Benefits**, Commitment Plus is a portfolio of owner privileges that lasts throughout your warranty. For expert product information, Roadside Assistance or other services, call 1-800-GMC-8782.

TRAVEL BENEFITS AND ROADSIDE ASSISTANCE Available around the clock: trip routing service, a program for reimbursement for trip interruption due to necessary warranty repairs, towing, flat tire change, jump-starts and more for 5 years or 100,000 miles (whichever comes first).

COURTESY TRANSPORTATION Available at participating dealers: shuttle service, reimbursement of certain public transportation or fuel expenses for overnight warranty repairs, and courtesy rental for overnight work repairs. See your dealer for details.

GMC OWNER CENTER A complimentary, one-stop resource to enhance your GMC ownership experience. It's easy to sign up. Just go to gm.com/gmownercenter/gmc.

ONSTAR



OnStar is a core asset of your Yukon. Benefiting from more than a decade of innovative development, it is both a highly advanced technology—fully integrated within the vehicle—and a warm human service. Standard on all Yukon models are 6 months of the OnStar Directions & Connections Plan, including the convenience of available Hands-Free Calling. It also includes Automatic Crash Response, Stolen Vehicle Assistance, link to Emergency Services, Roadside Assistance, Remote Door Unlock, OnStar Vehicle Diagnostics, Crisis Assist and Remote Horn and Lights. OnStar services require vehicle electrical system (including battery), wireless service and GPS satellite signals to be available and operating for features to function properly. OnStar acts as a link to existing emergency service providers. Visit onstar.com for coverage maps, details and system limitations. Services vary with conditions.

HANDS-FREE CALLING

Available OnStar Hands-Free Calling capability is built into your Yukon. It's there when your cell phone is unavailable, its battery is low, you can't reach it easily or you left it at home or in the office. Your Hands-Free Calling system is the right choice whenever you need an easy way to make and receive calls—at the touch of the phone icon on the rearview mirror or the steering-wheel-mounted controls. Voice-activated dialing is convenient because you don't have to dial when you are at the wheel. And Hands-Free Calling is reliable because it's specially designed for better reception and fewer dropped calls in areas of limited cellular reception.

ONSTAR TURN-BY-TURN NAVIGATION

Standard on all Yukon models are 6 months of the OnStar Directions & Connections Plan that adds innovative, easy-to-use Turn-by-Turn Navigation plus Information and Convenience Services and Driving Directions. With Turn-by-Turn Navigation, you simply tell the OnStar Advisor your intended destination, and directions will automatically be sent to your Yukon. If you drive off course, the system can reroute you to your intended destination. An automated voice then guides you turn-by-turn until you arrive at your destination. Turn-by-Turn Navigation is further enhanced with eNAV, allowing you to send MapQuest™ directions directly to your vehicle. No need to print out directions; just call them up with simple voice commands.

SIRIUSXM SATELLITE RADIO



SiriusXM Satellite Radio³ is standard on all Yukon models. It includes 3 trial months of service. SiriusXM Satellite Radio makes your drive come alive with commercial-free music channels from virtually every genre, artist-dedicated channels, live performances and more. Tune in to live play-by-play from the biggest sports, exclusive entertainment from top personalities, compelling talk, hilarious comedy, world-class news, local traffic and weather and family-friendly programming. Welcome to the world of satellite radio. Visit siriusxm.com for details.

GMC CERTIFIED SERVICE

 To help your Yukon live up to its performance promise, GMC Certified Service—found exclusively at your GMC dealer—is there. With all the engineering excellence in Yukon, GM-trained technicians have the expertise to care for all of it.

A NOTE ON CHILD SAFETY Always use safety belts and the correct restraint for your child's age and size. Even in vehicles equipped with the Passenger Sensing System, children are safer when properly secured in a rear seat in the appropriate infant, child or booster seat. Never place a rear-facing infant restraint in the front seat of any vehicle equipped with a passenger air bag. See the Owner's Manual and child safety seat instructions for more safety information.

ADDITIONAL NOTES

TRAILERING AND OFF-ROAD INFORMATION Please carefully review the Owner's Manual for important safety information about trailering or off-road driving in your vehicle.

IMPORTANT WORDS ABOUT THIS CATALOG We have tried to make this catalog comprehensive and factual. We reserve the right, however, to make changes at any time, without notice, in prices, colors, materials, equipment, specifications, models and availability. Specifications, dimensions, measurements, ratings and other numbers in this catalog and other printed materials provided at the dealership or affixed to vehicles are approximates based upon design and engineering drawings and prototypes and laboratory tests. Your vehicle may differ due to variations in manufacture and equipment. Since some information may have been updated since the time of printing, please check with your GMC dealer for complete details. GMC reserves the right to lengthen or shorten the model year for any product for any reason, or to start and end model years at different times.

FLEET ORDERS Some standard content may be deleted with fleet orders. See dealer for details.

ENGINES GMC products are equipped with engines produced by GM Powertrain or other suppliers to GM worldwide. The engines in GMC products may also be used in other GM makes and models.

GMC.COM See more of Yukon on our Web site: gmc.com/yukon. More photos and information; hot links to related subjects; convenient dealer locator; pricing guide, spec out your own vehicle. Or call 1-800-GMC-8782.

AN IMPORTANT NOTE ABOUT ALTERATIONS AND WARRANTIES Installations or alterations to the original equipment vehicle (or chassis) as distributed by General Motors are not covered by the General Motors New-Vehicle Limited Warranty. The special body company, assembler, equipment installer or upfitter is solely responsible for warranties on the body or equipment and any alterations (or any effect of the alterations) to any of the parts, components, systems or assemblies installed by GM. General Motors is not responsible for the safety or quality of design features, materials or workmanship of any alterations by such suppliers.

NEW-VEHICLE LIMITED WARRANTY All GMC light-duty vehicles come with a fully transferable, no-deductible 5-year/100,000-mile (whichever comes first) Powertrain Limited Warranty. GM vehicles registered in the U.S.A. are also covered for 3 years or 36,000 miles (whichever comes first). Coverage includes tires and towing to your nearest GMC dealership. Repairs will be made to correct any vehicle defect and most warranty repairs will be made at no charge. In addition, rust-through corrosion will be covered for 6 years or 100,000 miles (whichever comes first). See dealer for details.

ASSEMBLY GMC vehicles and their components are assembled or produced by different operating units of General Motors, its subsidiaries or suppliers to GM worldwide. We sometimes find it necessary to produce GMC vehicles with different or differently sourced components than originally scheduled. Since some options may be unavailable when your vehicle is assembled, we suggest that you verify that your vehicle includes the equipment you ordered or, if there are changes, that they are acceptable to you.

GMMOBILITY.COM [1-800-323-9935] GM Mobility offers financial assistance for eligible adaptive equipment to make automotive travel easier for persons with disabilities or special transportation needs. To learn more about special GM Mobility offers, visit gmmobility.com.

GMCARDMEMBERSERVICES.COM Did you know about the family of reward credit cards that can help you get a great deal on a new GM car, light-duty truck, SUV or crossover? With a GM reward card, you accrue earnings on every credit card purchase to use toward the purchase or lease of an eligible new GM vehicle. With three cards to choose from, you're sure to find one that suits you.

¹If you subscribe after your trial period, *subscriptions are continuous until you call SiriusXM to cancel*. See SiriusXM Customer Agreement for complete terms at siriusxm.com. Other fees and taxes will apply. All fees and programming subject to change. For more information about NavTraffic, visit siriusxm.com/navtraffic. For more information about Travel Link, visit siriusxm.com/travellink. XM satellite service is available only to those in the 48 contiguous USA and DC.

©2012 General Motors. All rights reserved. GM, the GM logo, GMC, the slogans, emblems, vehicle model names, vehicle body designs and other marks appearing in this catalog are the trademarks and/or service marks of General Motors, its subsidiaries, affiliates or licensors. Bose, Centerpoint, AudioPilot and SurroundStage are registered trademarks of the Bose Corporation. iPod and iPhone are registered trademarks of Apple, Inc. Facebook is a registered trademark of Facebook, Inc. Twitter is a registered trademark of Twitter, Inc. YouTube is a registered trademark of Google, Inc. Sirius, XM and all related marks and logos are trademarks of SiriusXM Radio, Inc.



VISIT US AT GMC.COM



FACEBOOK.COM/GMC



TWITTER.COM/THISISGMC



YOUTUBE.COM/GMC

13BMCYUKRC-25