



BMW
Z4 Roadster

sDrive28i
sDrive35i
sDrive35is



The Ultimate
Driving Machine®

THE BMW Z4.

THE POWER TO FREE YOURSELF.

BMW EfficientDynamics
Less emissions. More driving pleasure.

Contents

BMW Z4 Roadster
04 115 Exterior
16 121 Interior

Technology

22 123 BMW EfficientDynamics
24 125 Engines
26 127 Transmissions
28 129 Driving Dynamics Control
30 131 Retractable Hardtop
32 133 Storage options
34 135 Safety features | iDrive
36 137 BMW ConnectedDrive

Equipment

38 141 Exterior colors | Upholsteries | Interior trims | Combinations
42 143 Z4 sDrive35i High Performance
44 145 M Sport Package
46 147 Exclusive Canyon Brown Package
48 149 Exclusive Citrus Yellow Package
50 156 Equipment features and options
57 Safety Illustrations
58 159 Build Your Own | Technical data
60 161 BMW Services

Get the latest information on BMW standard and optional features, packages and technical specifications. Visit bmwusa.com, select the BMW model of your choice, and click on "Features & Specs."



Want the inside scoop on BMW?
You can find us on Facebook® at
facebook.com/bmwusa



Z4 sDrive35i shown with the following equipment:

Engine: 24 valve, TwinPower Turbo
Max. horsepower: 300-hp, inline six-cylinder
Wheels: Multi Spoke (5M) 20" light alloy
Interior: Beige Kansas Leather

BMW Z4 sDrive35i

For information on paint colors, upholstery and interior trims, please refer to pages 38 - 41.



SOPHISTICATION AND SPORT UNDER THE SUN.

Introduce yourself to the BMW Z4 Roadster, a thrilling expression of art and innovation in one exhilarating package. Refreshing and stylish, the Z4 launches roadster design and performance into the next decade and beyond. Its classic characteristics – a long hood, powerful haunches, swept-back seats and broad, aggressive front end – are enhanced by a mastery of modern innovation. A lightning-fast transmission, with refined steering and suspension, paints the car into curves like a brush. Attention to safety and comfort features in the enlarged cabin have reached luxurious new heights. And topping it all off is an ingenious, retractable hardtop that makes driving the Z4 Roadster a decidedly year-round experience. This is style and performance for any season.

Exterior 04105







**DESIGN, ENGINEERING, GRACE.
ALL IN ONE PACKAGE.**

Start the engine and the broad front end snails with anticipation, invoking the wealth of power at your command. The Z4's long hood arches forward from the windshield, sweeping over the front wheels and down to the dual Xenon headlights astride the familiar kidney grille. Behind the low-slung cockpit, the tail end rises like a wave of power yearning to break over the asphalt. Put the car in gear and pour yourself into heart-stirring curves, then thunder over the open roadways. Make your destinations as rustic or as elegant as you please. You'll arrive with a thrilling display of power and grace.



IMPRESSIONS ON AN ASPHALT CANVAS.

From the classic seating – strategically swept back over the Roadster's road-hugging, rear-wheel thrust – you'll discover a broad palette of innovations to color your travels. A 7-speed Double Clutch Transmission shifts with imperceptible efficiency automatically, or manually by using the paddles on the leather-wrapped sport steering wheel. At a single touch, the Driving Dynamics Control feature lets you select the muscular SPORT or SPORT+ settings, or NORMAL, s more cushioned ride, conditioning the responses of the gas pedal, power steering, shifting and stability thresholds. Roadsters with Adaptive M Suspension adjust the damper over a range of conditions for greater road feel or a perfectly smooth drive; select the SPORT setting and you'll experience athletic agility. The variety of performance settings at your command provides a personalized collage of driving experiences. Whatever your medium, welcome to the art of the road.

Get the latest information on BMW standard and optional features, packages and technical specifications. Visit bmwusa.com, select the BMW model of your choice, and click on "Features & Specs."





From the sunshine of South Beach to the snows of New England, you'll find the Z4 Roadster hungry to explore a whole year's worth of driving conditions. Stargazing in Monterey? At the push of a button, the retractable aluminum hardtop folds into the trunk in just 20 seconds. Showers in Seattle? It shelters the cabin just as quickly. The hardtop also minimizes external noise while providing class-leading visibility at every point of the compass. Ample storage features, from discreetly folding compartments in the cabin to the trunk's through-loading system, provide space for all your accessories. The Z4 Roadster produces a special kind of everyday, practically: one that lets you leave the everyday behind.

Get the latest information on BMW, standard and optional features, packages and technical specifications. Visit bmwusa.com, select the BMW model of your choice, and click on "Features & Specs."

A ROADSTER – AND A RIDE – FOR ALL SEASONS.





From the driver's seat, it's obvious you are in a BMW Roadster. Access to the Z4's instrumentation and controls is precise and intuitive, clear and angled toward you. Inviting to the touch, the controls seem to come spontaneously to hand. When equipped with iDrive, the navigation, entertainment and communications buttons of the Controller are sculpted for easy tactile identification; you can operate numerous on-board systems instinctively with the push of a button or the turn of a knob. A high-resolution 8.8-inch Control Display renders pictures and text in rich, colorful details when not needed; it folds away into the dash. Every aspect of this cockpit was designed with one thing in mind: so there would be nothing to distract you from the thrill of the drive.

Get the latest information on BMW standard and optional features, packages and technical specifications. Visit bmwusa.com, select the BMW model of your choice, and click on "Features & Specs."



Enhancing the driving experience is the true order of the day. Take in the landscape and pursue your farthest horizons from a cabin that's both alluring and elegant. The Z4's sport seats offer generous amounts of shoulder- and elbowroom; with the top up, there is an amazing amount of headroom. When the top is left down, BMW's Sun-Reflective Technology helps keep even dark leather surfaces, like this Canyon Brown Extended Merino Leather, cooler to the touch. The dash, door panels and center console are luxuriously upholstered in Black Extended Leather throughout the cabin; stylish contrasting double seams denote BMW's quality craftsmanship. The Z4 Roadster interior—designed for adventure—and luxury.

Get the latest information on BMW-dependent and optional features, packages and technical specifications. Visit bmwusa.com, select the BMW model of your choice, and click on "Features & Specs."

BMW EFFICIENT DYNAMICS - VEHICLES THAT REQUIRE LITTLE AND GIVE A LOT.

BMW was one of the first automotive manufacturers to pursue efficient driving technologies – one part of our award-winning sustainability strategy. Our commitment to EfficientDynamics means we are continuously developing innovative systems that bring us closer to our long-term goal of emissions-free mobility. However, we remain equally committed to driving pleasure, which is being pursued in different ways: First, there is the continuing optimization of conventional diesel- and gasoline-powered models. Second, BMW hybrid vehicles are already on the road. Third, the first 100% electrically powered BMW – the BMW ActiveE – is being distributed in a field trial to customers. And fourth, the fleet of BMW Hydrogen 7 vehicles impressively demonstrated the potential for combining hydrogen drive with a combustion engine.

Since 1995 BMW has been able to reduce the CO₂ emissions of its entire fleet by approximately 30 percent. BMW has rolled out more than two million vehicles equipped with EfficientDynamics. 31 models already produce less than 225g of CO₂ per mile, and BMW intends to achieve a further 25 percent reduction by 2020. BMW EfficientDynamics represents the most comprehensive package of innovative technologies currently in production, for reducing fuel consumption and emissions while simultaneously creating The Ultimate Driving Machine®.

Different paths to the same destination: unmistakable BMW driving pleasure.

In early 2010 BMW launched its first production models with hybrid drive: the BMW ActiveHybrid 7 and the BMW ActiveHybrid X6. Both models offer an unparalleled combination of increased fuel efficiency, reduced emissions and thrilling performance. The BMW ActiveE, with its innovative 100% electric drive system, will introduce a whole new form of dynamic performance, paving the way for the future of emissions-free mobility. Finally, a completely new vehicle concept targeted at meeting the need for sustainable mobility in fast-growing metropolitan areas will soon become reality: the BMW i3.

➤ bmw-t-usa.com



BMW Vision EfficientDynamics: Vision becomes reality. In 2014 BMW plans to debut the BMW Vision EfficientDynamics test model – a 2+2 sports car featuring groundbreaking plug-in hybrid technology that combines sports-car performance with compact-class consumption. Powered by the latest-generation, full-hybrid system, the vehicle – in concept form – generates a total of 328 hp through a 161-hp, three-cylinder turbo diesel engine with 214 lb-ft of torque, as well as a hybrid synchronous engine on the front axle and fully hybrid drive system on the rear axle. With a range of up to 433 miles, its ratio of performance to fuel consumption is without equal, positioning BMW as the world's leading manufacturer of exceptionally efficient, sporty vehicles.

➤ bmwusa.com/efficientdynamics

AT A GLANCE: BMW EFFICIENT DYNAMICS INNOVATIONS IN THE BMW Z4 ROADSTER.



BMW TwinPower Turbo technology.

All three Z4 Roadster engines feature this innovative turbocharging technology that efficiently recycles the energy contained in exhaust gases, using a twin-scroll charger with a double-flow exhaust system.

High Precision Direct Injection.

Turbocharging is traditionally known for boosting power at the expense of fuel efficiency. However, in this latest-generation direct fuel injection system, the piezo injectors are positioned very close to the spark plugs. They inject fuel at high pressure, with extreme precision, for very efficient combustion. As a result, the Z4 Roadster achieves greater power with excellent fuel efficiency.

Double-VANOS valve timing.

BMW's VANOS valve timing system "steers" the points in the combustion cycle when valves open and close. Double-VANOS operates on both the intake and exhaust camshafts. Electronically controlled in response to engine speed, temperature and load, it reduces emissions and enhances low- to medium-speed torque, as well as fuel efficiency.

Brake Energy Regeneration.

To supply a battery with electrical energy, the generator (alternator) is usually driven using engine power, which requires fuel. With Brake Energy Regeneration, the alternator generates electricity only when you take your foot off the accelerator. Kinetic energy that was previously unharvested is transformed into electrical energy, which is then fed into the battery. In this way, electricity is generated without consuming fuel.

Auto Start-Stop function.

Even when idling, such as at a stop sign, an engine burns fuel. BMW's Auto Start-Stop function enhances fuel efficiency by switching off the engine. (The intelligent electronics system first checks the battery charge level and calculates if other electric systems, like the heated rear windshield, need more energy.) Once the brake pedal is released, the engine starts up again almost instantly. A Start-Stop signal in the Display indicates the function is active.

8-speed Sport Automatic transmission.

The close spacing of gear ratios in the 8-speed Sport Automatic transmission makes maximum use of the optimum rev range, reducing fuel consumption and allowing smoother shifts.

Electric Power Steering.

Unlike conventional hydraulic steering systems, electrical power steering only uses energy during actual steering. When the steering wheel position is constant – for example, at highway speeds – the electric motor is inactive.

Lightweight construction.

Lightweight aluminum is used throughout BMW vehicles – in the front axle, for example, or for the suspension, in the hood and in the retractable hardtop. The TwinPower Turbo engines in all Z4 Roadster models are all aluminum. These weight savings lead to lower fuel consumption and better axle load distribution for more agility – especially in curves.

Not all BMW EfficientDynamics features are available on all models. Please see your authorized BMW center for details.

BMW EfficientDynamics
Less emissions. More driving pleasure.

SATISFYING POWER SERVED UP IN THREE EXCITING FLAVORS.

Engines that power innovation. Year after year, numerous BMW engines have garnered accolades for their output, refinement and high-revving ability. Among this pantheon of powerplants, the latest generation to be honored is the TwinPower Turbocharged variants. It's only natural, then, that BMW has provided three exceptional TwinPower Turbo engines for the Z4 Roadster. Each one accelerates with a force that throws you back in your seat and doesn't stop until redline. And each is designed to deliver on BMW's EfficientDynamics philosophy: increased power with decreased fuel consumption and emissions. Whichever engine you select, you'll enjoy the thrill of BMW performance while helping to protect the environment every day.

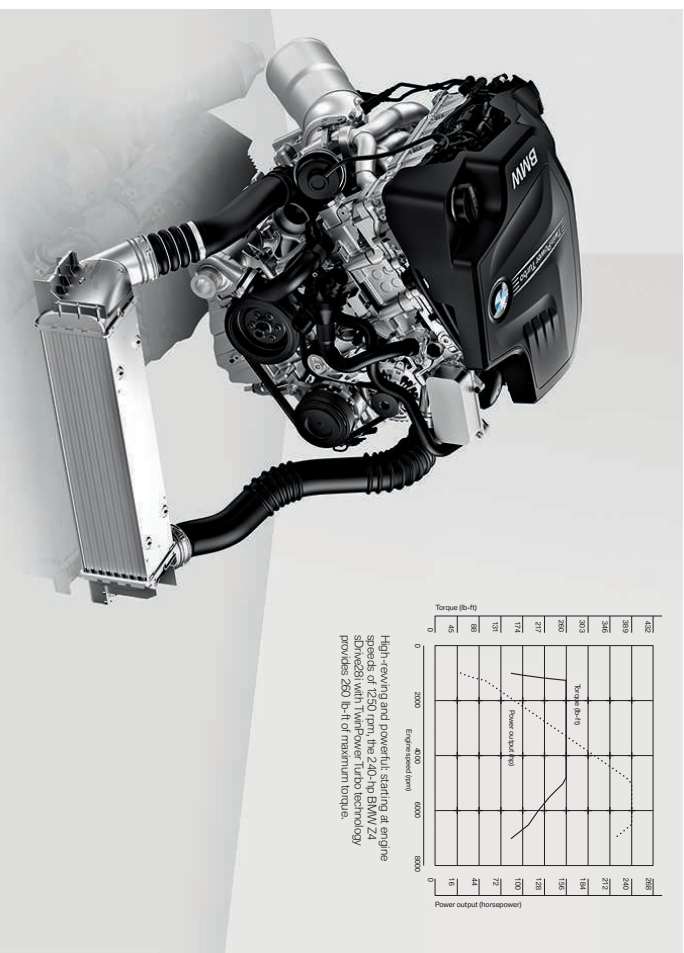

BMW Z4 sDrive28i. Small is the next big idea in engines – namely, BMW's mighty inline four-cylinder TwinPower Turbo. Displacing just 2.0 liters, this 240-hp marvel generates 260 lb-ft of torque at just 1250 rpm, for potent thrust that kicks in right from the start and continues all the way up to 4800 rpm. Lightweight and smooth-running, it incorporates BMW's award-winning High Precision Direct Injection, Valvetronic and Double-VANOS technologies. Its dynamic performance is equaled by spectacular fuel efficiency, taking you further on every gallon of gas than did its six-cylinder predecessor.

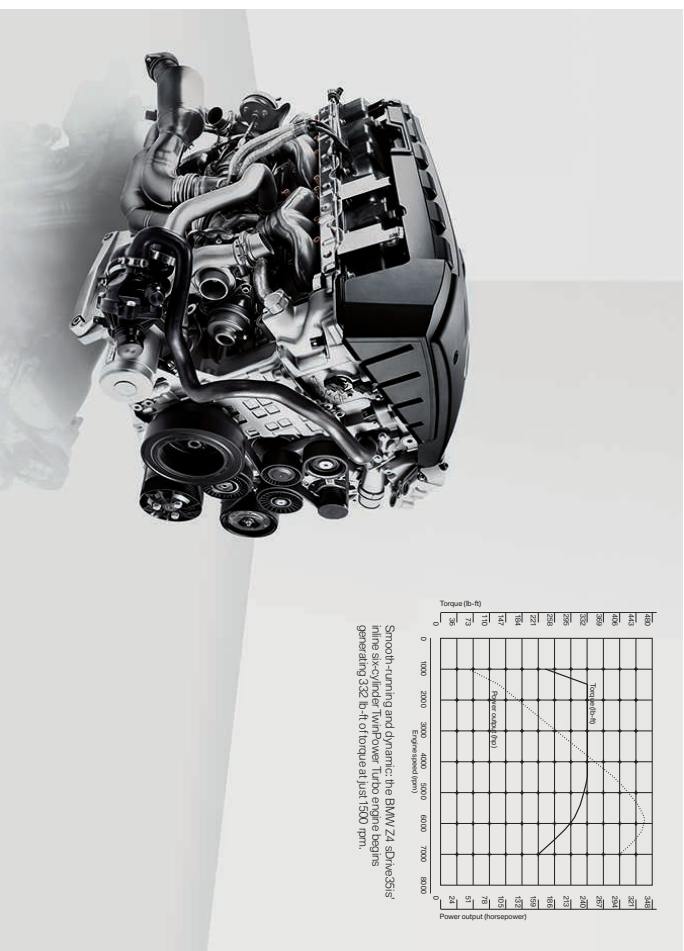

BMW Z4 sDrive35i. BMW's universally lauded inline six-cylinder TwinPower Turbo engine features High Precision Direct Injection and BMW's Valvetronic variable intake technology, which helps the engine "breathe" better. The result: turbo lag is virtually eliminated, while posting one of the most fuel-efficient ratings in its class. In just 5.0 seconds,¹ the Z4 sDrive35i is rushing past 60 mph, thanks to a maximum output of 300 hp at 5800 rpm. Adding to the excitement, 300 lb-ft of peak torque begins at just 1400 rpm and doesn't end until 5000 rpm.

BMW Z4 sDrive35i. To create the Z4 sDrive35i engine, BMW gave its multi-award-winning turbocharged inline six 35 more horsepower, 32 more lb-ft of torque – and an additional 37 lb-ft of temporary torque boost. An adrenaline-producing burst of acceleration propels it from 0–60 in 4.8 seconds.² Of course, BMW EfficientDynamics ensures that every ounce of fuel is optimized during the performance.

¹ BMW AG test results with 7-speed Double-Clutch Transmission, 5.1 seconds, manual transmission. BMW urges you to obey all posted speed laws and always wear safety belts.
² BMW AG test results. BMW urges you to obey all posted speed laws and always wear safety belts.

UNPARALLELED POWER DESERVES UNPARALLELED POWER MANAGEMENT.

World-class athletic performance demands more than world-class muscle. Regulate the rhythms of power with breakthrough transmissions. The 6-speed manual is specially designed for the Z4 Roadster, with short-throw gear shifts for lightning-quick gear changes. A fuel-saving technology included with the Z4 sDrive 28i when equipped with a manual transmission is the Auto Start-Stop function, which turns off the engine when you come to a stop – then instantaneously restarts the engine when the clutch is depressed. The 6-speed Sport Automatic transmission selects the most efficient gears quickly and precisely. This lowers fuel consumption and reduces shift times to a minimum, while the slightest pressure on the gas yields spontaneous thrust. The 7-speed Double Clutch Transmission uses seven gears operating between two transmission structures in one large housing. First, third, fifth and seventh gears are grouped in one structure, second, fourth and sixth gears are grouped in the other. When upshifting or downshifting, the system switches between the two structures, so that while one gear is being disengaged, the next is already in position. Shifting takes milliseconds, adjusting thrust between heartbeats without a moment's loss of force. This dynamic connection to the engine gives you precise power for every situation – from accelerating and cornering to grand stunts through hills and mountains. And along the drive, the automatic transmission allows you to choose between two driving systems: the smooth comfort of D mode, or S mode for sportier shifting. For a still more seamless connection to the engine and the road, use the racing-inspired shift paddles on the sport steering wheel. Whatever your driving style, we've got the perfect transmission for you.

Get the latest information on BMW standard and optional features, packages and technical specifications. Visit bmwusa.com, select the BMW model of your choice, and click on "Features & Specs."

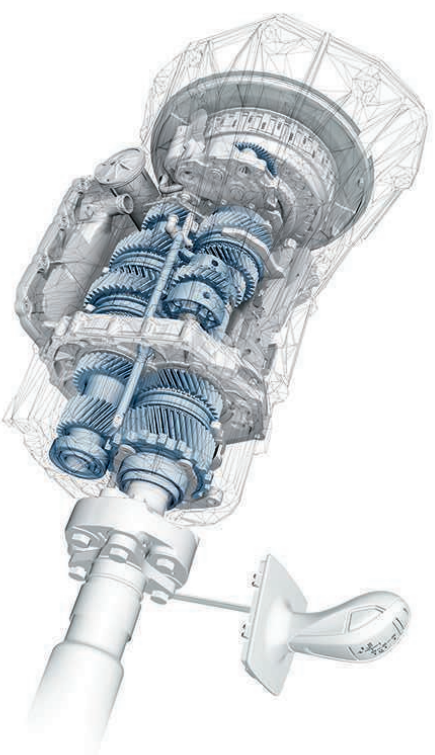

In the 7-speed Double Clutch Transmission, even and uneven gears are distributed across two power trains. So while one gear is being disengaged, the next is already in position, for the fastest shifts with maximum precision.



MAKE EVERY ROAD A PERSONALIZED DRIVING EXPERIENCE.



Coastal highways, country lanes, Route 66, Broadway – from a sprint to the local green market, to a marathon through the mountains, the Z4 Roadster opens up unparalleled vistas of driving pleasure. An artfully tuned chassis and suspension ensure excellent road contact and feel. The Z4 includes Driving Dynamics Control, a feature that recalibrates the systems that affect the entire ride – acceleration, steering, stability response, gearshifting – from COMFORT to SPORT to SPORT+, and does so more precisely and completely than any comparable vehicle. Set it to COMFORT and you'll arrive in sublime comfort and style at any destination. Even during a long journey you won't break a sweat – unless you want to. In that case, consider transforming this comfortable tourer into a heart-stopping sports car by setting it to SPORT. All it takes is the push of a button.

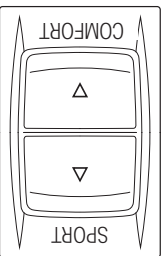

Now that you're in SPORT mode, get ready for a more direct response to steering input and your right foot's requests for acceleration. You'll love curving in and out of bends and hairpins with a steering sensitivity that brings the roadway right into your hands. Taking corners becomes a form of modern calligraphy, written in power and grace. In the mounting momentum of straightaways, the accelerator pedal pours on the power, leaving trails of delight wherever you pass. And that's only the beginning. Set it to SPORT+ mode and you can push the driving arts to the edge of exuberantism. This is achieved by allowing a greater degree of wheelspin, enabling you to take a bend in a controlled drift. This effect can also be achieved by manually activating Dynamic Traction Control (DTC); an electronic limited slip differential allows wheelslip, then draws powerful acceleration out of deep corners. The result is a breathtaking, precise geometry of lines and curves, sketched on the pavement by your own hands behind the wheel. The Adaptive M Suspension's electronic response is so quick, a pothole encountered by the front wheel is immediately damped by the rear wheel. Such precise handling and response makes every outing a tour de force, a magnum opus – a masterpiece.

Get the latest information on BMW standard and optional features, packages and technical specifications. Visit bmwusa.com, select the BMW model of your choice, and click on "Features & Specs."



20 SECONDS FASTER THAN THE RAIN.

When sunshine turns to rain, or the first spring day blooms out of winter, in the Z4 Roadster you'll be in or out of the elements in 20 seconds flat. That's all the time it takes for the fully retractable hardtop to gently enclose the cockpit or fold into the trunk. A pleasant temperature is constantly maintained inside the cabin by automatic climate controls so sensitive, they even respond when the top moves up or down. Need to load groceries when the top is down? Use the Comfort Loading feature to raise the roof out of the way. What's more, the Z4's intelligent lightweight aluminum hardtop keeps the Z4's gravity low, so driving dynamics remain high – leaving the gray skies far behind.

TWO SEATS. ELEVEN PLACES.



Through-loading with ski bag



Storage compartment in the through-loading partition

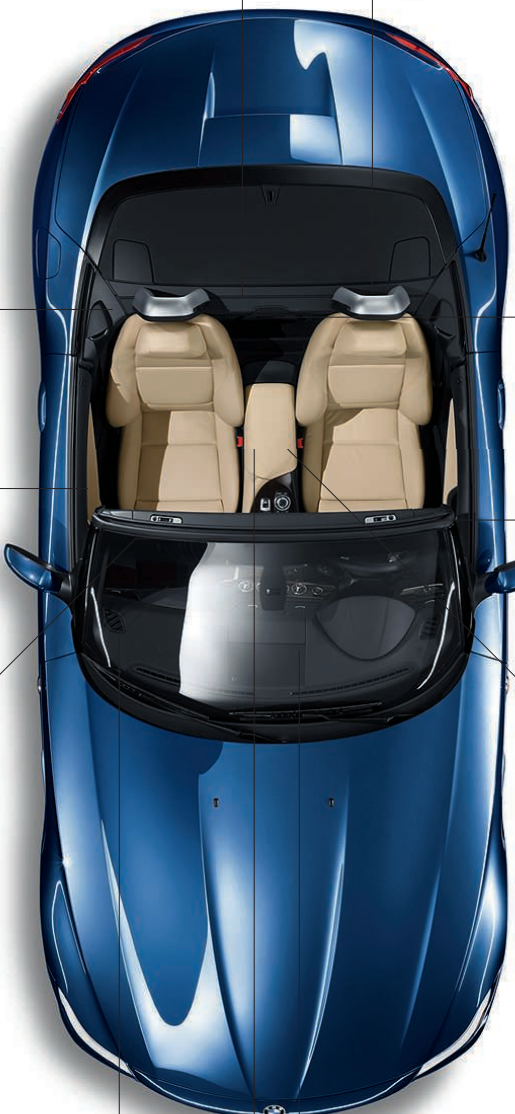

Rear clothes hooks

Storage compartment behind the seats



Driver's-side folding compartment



Two cupholders in the center armrest and a third, clip-in cupholder



Folding compartment on instrument panel



Storage compartments in center console



Glove compartment



Net in passenger footwell

Door-mounted folding compartment (both sides)



The BMW Z4 Roadster inspires you to enjoy life to the fullest. It's crafted with a surprising amount of storage space so you can take your gear, too. BMW knows that you'll want to maximize open-air driving time, so numerous storage spaces, such as the folding compartments in the doors, are designed to keep your possessions secure. Just behind the seatbacks is a shelf with netting to secure your laptop, books, and bag or briefcase. The trunk accommodates a 46-inch golf bag, or medium-size luggage. When the hardtop is up, a partition in the trunk can be moved to create even more space. In addition to a spacious glovebox, there are covered storage compartments in the center console and dash.

The Z4 Roadster is the first in its class to offer a through-loading system with a protective ski bag. Use this additional space to stow a second 46-inch golf bag or – even with the roof down – two pairs of skis. Add the Cold Weather Package, and the Z4 includes a storage package that gives you greater possibilities: Hang jackets, grocery bags and more on two rear clothes hooks. Keep books, glasses, tissues and more safely stowed in storage nets located in the passenger footwell and behind the seats. Lashing straps keep everything in place in the trunk. There's even a secret storage area. So whether you're up for a day of sports, a business conference, or just a picnic in the country, your Z4 Roadster is ready to go.

SHELTER IN ANY STORM.

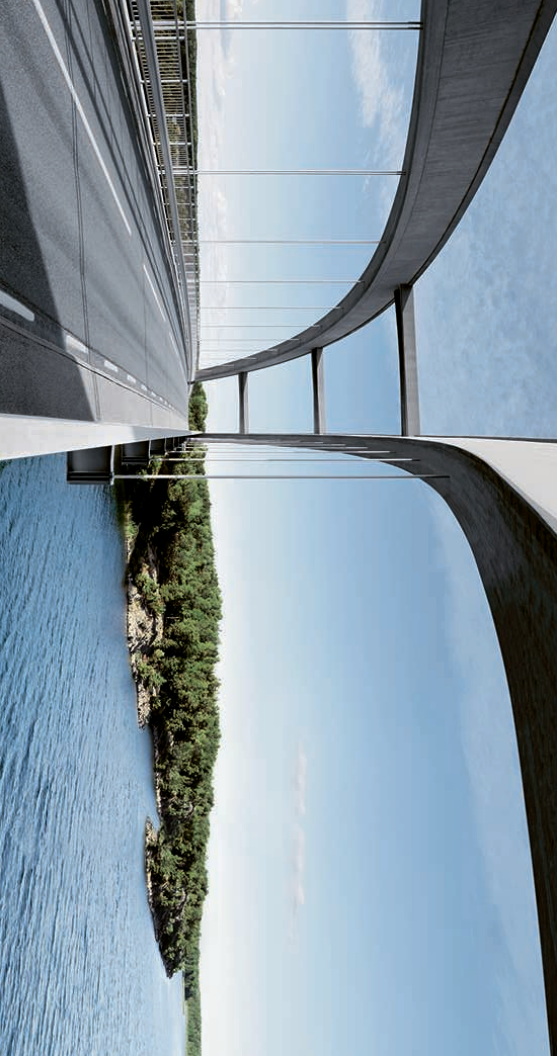

The engineering of the BMW Z4 Roadster is focused as much on safety as on performance. The Z4 features a host of innovative and powerful active and passive safety features. Active systems include Dynamic Stability Control (DSC), which immediately detects and eliminates wheelspin. It enhances braking traction on slippery surfaces, and acts to keep the brakes dry when it senses moisture. If you need to brake suddenly, the Brake Stand-by and Dynamic Brake Control features reinforce the speed and strength of your stopping action, while Adaptive Brake lights signal a vivid warning to following vehicles. In the dark and even through turns, brilliant Xenon Adaptive Headlights highlight obstacles in your path. In case an accident cannot be avoided,

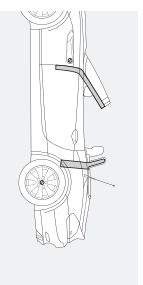

BMW's Rollover Protection System includes two steel roll bars behind the headrests and high-strength tubular steel integrated into the windshield support.

BMW's Advanced Safety Systems spring into action. In addition to a full complement of passive safety features – airbags, safety-belt pretensioners and a reinforced structure – the cockpit includes a tubular steel windshield frame and fixed high-tensile roll bars behind the seats, offering optimum protection even with the top down. In the crucial first moments following a collision, the interior lights come on, doors automatically unlock, and emergency lights begin flashing. With BMW Assist™ the vehicle automatically relays its position and the severity of the impact to the Response Center, response specialists then dispatch needed emergency services. Trust BMW to deliver driving excitement – as well as on-the-road confidence.

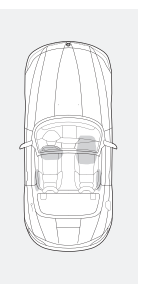

Head and upper-body airbags, at both front and side, help cushion the head, neck and pelvic area in the event of a collision.

iDRIVE: CONTROL YOUR DRIVING ENVIRONMENT SINGLE-HANDEDLY.



Whether you're commuting or touring, you want to be totally comfortable, informed, and entertained by your favorite songs. Welcome to iDrive, a benchmark in automotive technology for the BMW Z4 Roadster. Included with the Navigation system, iDrive offers intuitive, ergonomic control with easy reach on the center console.

The system places a wide variety of entertainment and communication options at your fingertips. Using the iDrive Controller, simply tilt, rotate, push and click your way through any series of commands. Distinctly shaped buttons located above the Controller wheel let you directly call up the CD Player, Radio, Telephone and Navigation menu choices without taking your eyes off the road. In addition, six programmable memory buttons on the dash allow you to store the settings of your choice, from preferred radio stations to frequently dialed phone numbers (if so equipped.) The iDrive system also includes Voice command, making it

easy to access your favorite music or place calls while keeping your attention on traffic.

The system also features a high-resolution 8.8-inch monitor that pops up from the dash, and then retracts neatly out of sight. All menu items are rendered in a clear, readily understandable graphic form, for quick comprehension at a glance. Visual operating cues, like an image of the Controller, make it even easier to find your way around. Choose the Navigation function and your iDrive Controller transforms into a virtual tour guide, complete with 3-D maps and select points of interest.

The integrated Entertainment Server lets you transfer favorite digitized songs to a 12 GB hard drive. Transfer your important data files from a pocket USB drive to the server – and back. All this and more makes the iDrive an indispensable on-board personal assistant.

Get the latest information on BMW standard and optional features, packages and technical specifications. Visit bmwusa.com, select the BMW model of your choice, and click on "Features & Specs."



STAY TOTALLY IN TOUCH WHEREVER YOU GO – WITH BMW CONNECTED DRIVE.

Whether you're far from home or just in the next town, BMW Assist™ offers convenience and peace of mind. There are new ConnectedDrive features that extend BMW's leadership in wireless communications. Marvel at an extensive array of new Mobile Office functions. Get a visual image of your callers. With BMW Assist, you enjoy all this – and more.

BMW Assist gives you peace of mind knowing that a friendly response specialist is there to help you 24/7, at the touch of a button. The Safety Plan includes Automatic Collision Notification, Emergency Request (SES), TeleService, Enhanced Roadside Assistance, Door Unlock, Stolen Vehicle Recovery, Customer Relations and MyInfo. The Convenience Plan adds Personalized Directions, Traffic and Weather reports, BMW Online and Concierge services for restaurant and hotel recommendations, with the destination address and phone number sent to your BMW. Make up to four operator-assisted calls per year with Critical Calling if your mobile phone is not available or its battery is discharged.

Use the time you spend in your vehicle even more effectively with BMW's Mobile Office feature! For example, when your vehicle is paired with a selected Bluetooth® interface, text messages and emails are transferred to your iDrive Display screen – and our system even reads them aloud to you. Thanks to Bluetooth audio streaming, you can enjoy wireless playback of your music files; your personal audio library can even be accessed via the iDrive Controller.

What's on today's agenda? Bring up the **Calendar** and **To-do List** on your Display screen while en route, to help you stay on schedule. Need to call your 11 o'clock appointment? Use the iDrive Controller knob to click on the **phone number** in the Calendar – and it's ringing. Meeting with several people? Conduct conference calls; the Display screen keeps you informed of the status of incoming calls. Who's calling you? If you've uploaded photos to your on-board phonebook, you'll see the caller's picture. Even missed calls are listed on the Display screen. It's never been easier to stay in touch while in transit.

Enhanced functions for the iPod® and USB adapter add to the ease and pleasure of using your iPod or iPhone®. Want to know which CD that song comes from? The album cover is shown on your Display screen. Don't purchase additional cables – your iPod or iPhone's original USB cable connects to your BMW's USB port. Another rare feature: with BMW Assist and Bluetooth audio streaming, you can wirelessly play music through the BMW audio system from any Bluetooth compatible music player or mobile phone, from anywhere in your vehicle. In fact, the audio library appears on the Display screen, where you can use the iDrive Controller knob to make your selection.

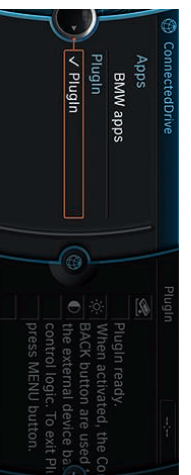
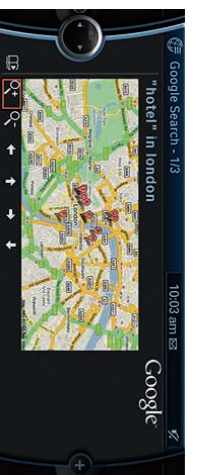
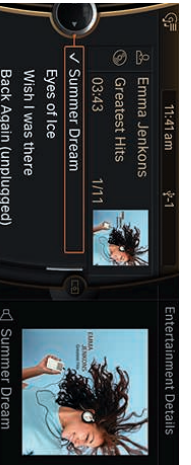

MyInfo allows you to send business locations and street addresses to your BMW from Google Maps™. Destinations and phone numbers can be accessed and exported to your Navigation system for immediate route guidance, while you can call the destination with your Bluetooth linked phone.

BMW Online allows online access to up-to-date fuel prices and gas station locations; the latest weather forecasts, advisories and warnings; Dow Jones, S&P 500 and NASDAQ indices; and the powerful reach of the Google Maps database – all delivered on the Control Display inside your vehicle. Access news headlines and have them read aloud via Text-to-speech technology. "Send to Mail" pinpoints your current location and planned destination, and allows you to send the information to any smartphone or email account. Then it's just a quick hyperlink to Google Maps for your friends and family to see where you are and where you're going.

BMW Apps lets you access Social Networks, music PlugIn and Video Playback through your iPhone, and see them on the Display screen.² Tune in to Web radio and search for stations from around the globe by name, location or genre; you can also store your favorite stations, find similar stations, display station information, and change the quality of the audio. Your favorite genres are stored on your iPhone, so you can take them with you from one vehicle to another.

Access content from your **Twitter™** and **Facebook®** accounts to stay on top of what's happening with friends and family.² The system can even read posts aloud, so you can keep your focus on the road. You can quickly post prewritten tweets that are further personalized by your BMW to let everyone know where you are and that you're enjoying the drive.

When you select **PlugIn** from the BMW Apps menu, the iPhone exports a typical iPod look and control to your BMW through the video connection.² You can then search for your favorite music by playlist, artist, album, song, genre or composer, just as you would on your iPhone.

Please note: The BMW App must be installed on your iPhone for the PlugIn to connect.
² Requires BMW Apps option and an iPhone.
 Get the latest information on BMW standard and optional features, packages and technical specifications. Visit bmwusa.com, select the BMW model of your choice, and click on "Features & Specs."

The following pages show the colors and materials available for the BMW 74 Roadsters. Use these samples to compare paint, upholstery, trim colors and combinations. Please note that these samples are representations; they are not exact reproductions. To see the actual colors, visit your local BMW center. They will be happy to show you original samples and assist you with special requests.

Exterior colors

	300 Alpine White (Non-metallic)		A61 Crimson Red (Non-metallic)
	688 Jet Black (Non-metallic)		B21 Atacama Yellow (Non-metallic)
	394 Titanium Silver Metallic		A92 Orion Silver Metallic
	A92 Space Gray Metallic		A75 Melbourne Red Metallic
	A76 Deep Sea Blue Metallic		475 Black Sapphire Metallic
	A96 Mineral White Metallic		

Upholsteries

	KCSW Black Leatherette		GNSW Black Alcantara / Nappa Leather with yellow stitching	
	LYCV Beige Kansas Leather		LWYV Walnut Kansas Leather	
	LYDT Coral Red Kansas Leather		LYSW Black Kansas Leather	
	PACV Beige Extended Kansas Leather		PASV Walnut Extended Kansas Leather	
	PADT Coral Red Extended Kansas Leather		PASW Black Extended Kansas Leather	
	LKWV Canyon Brown Extended Merino Leather			

Recommended color combinations

Upholstery materials	Kansas Leather ²					Extended Kansas Leather ³					Extended Alcantara Leather ⁴	Black Alcantara Leather ⁵
	Black	Beige	Walnut	Coral Red	Black	Beige	Walnut	Coral Red	Black	Canyon Brown		
Upholstery colors	Black	Beige	Walnut	Coral Red	Black	Beige	Walnut	Coral Red	Black	Canyon Brown	Black Alcantara	
Exterior colors												
300 Alpine White (Normal) ¹	•	•	•	•	•	•	•	•	•	•	•	
A61 Crimson Red (Normal) ^{1,7}	•	•	•	•	•	•	•	•	•	•	•	
668 Jet Black (Normal) ^{1,7}	•	•	•	•	•	•	•	•	•	•	•	
B21 Alcantara Yellow (Normal) ⁷											•	
354 Titanium Silver Metalic ²	•	•	•	•	•	•	•	•	•	•	•	
A92 Orion Silver Metalic ^{2,7,8}	•	•	•	•	•	•	•	•	•	•	•	
A52 Space Gray Metalic ²	•	•	•	•	•	•	•	•	•	•	•	
A75 Makourne Red Metalic ^{2,9}	•	•	•	•	•	•	•	•	•	•	•	
A76 Deep Sea Blue Metalic ²	•	•	•	•	•	•	•	•	•	•	•	
475 Back Sapphire Metalic ²	•	•	•	•	•	•	•	•	•	•	•	
A96 Mineral White Metalic ²											•	

Interior trims

4CG Silver Metal ¹	•	•	•	•	•	•	•	•	•	•	•
4BN Ash Grain Wood ⁸	•	•	•	•	•	•	•	•	•	•	•
4CE Arttracite Wood ⁴	•	•	•	•	•	•	•	•	•	•	•
4AD Brushed Aluminum ¹⁰	•	•	•	•	•	•	•	•	•	•	•
4MW Aluminum Carbon Shadow ¹¹	•	•	•	•	•	•	•	•	•	•	•
4ML Piano Black Wood ⁹	•	•	•	•	•	•	•	•	•	•	•



4CE Arttracite Wood

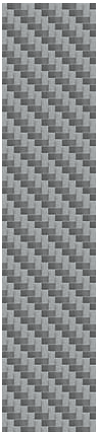

4MW Aluminum Carbon Shadow



4BN Ash Grain Wood



4AD Brushed Aluminum



4ML Piano Black Wood

¹ Standard in Z4 sDhw28k; not available in Z4 sDhw35f or Z4 sDhw35s.
² Standard in Z4 sDhw35f and Z4 sDhw35s; optional in Z4 sDhw28i.
³ Optional in Z4 sDhw35f and Z4 sDhw35s; not available in Z4 sDhw28i.
⁴ Requires Exclusive Canyon Brown Package or M SportCanyon Brown Package.
⁵ Requires Exclusive Canyon Brown Package or M SportCanyon Brown Package.
⁶ Not available with M Sport Package, M SportCanyon Yellow Package, or M SportCanyon Brown Package.
⁷ Not available on Z4 sDhw35s.
⁸ Optional.
⁹ Z4 sDhw28i and Z4 sDhw35f requires M Sport Package, M SportCanyon Yellow Package or M SportCanyon Brown Package.
¹⁰ Standard in Z4 sDhw35f; optional in Z4 sDhw28i and Z4 sDhw35s.
¹¹ Standard in Z4 sDhw35s; included in Z4 sDhw35f and Z4 sDhw28i M Sport Package.



Z4 sDrive35i High Performance 421/43



THE BMW Z4 sDRIVE35i: A NEW LEVEL OF POWERFUL PERFORMANCE.

The fire-breathing Z4 sDrive35i High Performance delivers pumped-up muscle, with horsepower rising to 335 and torque to 332 lb-ft – with a temporary boost to 369 lb-ft. With all this power on tap, oil and water coolers have been added to provide increased cooling capacity. Wisely, BMW also made a lightning-quick 7-speed Double Clutch Transmission with paddle shifters available. Underlining the added muscle, the front features the signature kidney grille with aluminum matte slats and chrome bezel, and distinctive Z4 sDrive35i badging behind the front wheels. In back, a sport exhaust system with chromed tailpipes adds a finishing touch to the rear diffuser of the M Sport rear bumper, and sets off the Melbourn Red Metallic paint. The distinctive Star Spoke (Style 255) 18-inch wheels with staggered size performance tires come standard. Double Spoke (Style 325M) 19-inch wheels (shown) are available as an option. Inside, M door sills, Aluminum Carbon Shadow trim, and an instrument cluster with an exclusive colored dial denote special status. Its refreshing design, complemented by powerful performance technology, makes the Z4 sDrive35i an unmistakable yardstick whenever luxury/performance roadsters are compared.



MAKE YOUR HEART BEAT FASTER. THE BMW Z4 M SPORT PACKAGE.

Give your Z4 sDrive28i or Z4 sDrive35i Roadster the competitive edge with the exclusive M Sport Package. An Aerodynamic kit, with specially shaped front and rear spoilers, sharpens its ability to cut through wind – and the competition. 18-inch Star Spoke (Style 325M) light alloy wheels with mixed tires show your sporting intentions; in the Z4 sDrive35i, you can also specify optional 19-inch V Spoke (Style 296) light alloy wheels. A multi-function M sport steering wheel ensures a firm grip, as does the Adaptive M Suspension, which delivers impressively agile road handling. On top of all these features, the BMW Z4 exudes even more self-confidence when painted in striking Deep Sea Blue Metallic. Inside, specially bolstered sport seats hold you tight in curves. And when you're not admiring the drive, feast your eyes on exclusive interior touches, including Aluminum Carbon Shadow trim, Anthracite headliner, and M badged door-sill finishers, footrest and gear shift lever.



3-spoke leather-wrapped multi-function M sport steering wheel lets you keep both hands on the wheel while changing radio stations, CD selections, volume, and making mobile phone calls (if so equipped). Thanks to BMW's Sun-reflective technology, it's always at a comfortable temperature, even when the Z4 Roadster is parked with the top down.



Star Spoke (Style 325M) light alloy wheels and run-flat performance tires.¹ In front: 18 x 8.0 wheels and 225/40 tires; in back: 18 x 8.5 wheels and 255/35 tires.



V Spoke (Style 296) light alloy wheels and run-flat performance tires.¹ In front: 19 x 8.0 wheels and 225/35 tires; in back: 19 x 9.0 wheels and 255/30 tires.

¹ Run-flat tires do not come equipped with spare tire and wheel. Driving over rough or damaged road surfaces, as well as debris, curbs and other obstacles, can cause serious damage to wheels, tires and suspension parts. This is more likely to occur with low-profile tires, which provide less cushioning between the wheel and the road. Be careful to avoid road hazards and reduce your speed, especially if your vehicle is equipped with low-profile tires. Performance tires are not recommended for driving in snow and ice.

Get the latest information on BMW standard and optional features, packages and technical specifications. Visit bmwusa.com, select the BMW model or your choice, and click on "Features & Specs."

EXCLUSIVE CANYON BROWN PACKAGE: A BOLD NEW LEVEL OF ELEGANCE.

Like dark chocolate in a beautiful wrapper, the Exclusive Canyon Brown Package is a treat for the senses. Rich Canyon Brown Extended Merino Leather and elegant Anthracite Wood trim fills the handcrafted cabin. Enhanced by contrasting double stitching, this velvety leather is finished not just on the highly supportive sport seats, but also on the dash, doors and center console. Treated with BMW's Sun-Reflective Technology, the seats and other surfaces stay cooler to the touch, even when parked with the top down. A new, eye-catching exterior paint, Mineral White Metallic, is available only with the Exclusive Canyon Brown Package or M SportCanyon Brown Package. Of course, you can also select from a wide array of other exterior choices to further enhance the Exclusive Canyon Brown Package – all in the best taste.



MAKE A BOLD STATEMENT WITH THE EXCLUSIVE CITRUS YELLOW PACKAGE.

Race the sun and rival its brilliance in a Z4 Roadster with the Exclusive Citrus Yellow Package. Fill your Z4 Roadster with special detailing inside and out, including sport seats with Alcantara/Neppa. Leather upholstery in black with yellow detailing, Piano Black Wood interior trim, door inserts in yellow Alcantara, and a high-contrast BMW headliner in ArtRace. Individualists will prize the eye-catching, exclusive Alcantara Yellow finish that works beautifully in conjunction with this unique package.





10-way manually adjustable sports seats with integrated fixed headrests can be adjusted for seat height, fore-and-aft positioning, seat tilt, backrest tilt, and two-way thigh support. The 2-way power-adjustable side bolsters as well as higher seat bolsters add lateral support during sporty driving maneuvers. (Shown in Canyon Brown Extended Merino Leather.)
Power lumbar support adds four-way adjustable comfort for the lower back. Lumbar support can be adjusted up/down and in/out.



6-way standard seats with integrated fixed headrests can be manually adjusted for seat height, fore-and-aft positioning, and backrest tilt. (Shown in Coral Red Kansas Leather.)
8-way power-adjustable seats include the above plus seat tilt, and offer two memory buttons for the driver's seat and exterior mirrors.



Heated seats offer three temperature settings for seat and backrest. In just a few short minutes, both driver and passenger can enjoy individualized warmth.



3-spoke leather-wrapped multi-function sport steering wheel lets you keep both hands on the wheel while changing radio stations, CD selections, volume, and making mobile phone calls (if so equipped).

Get the latest information on BMW standard and optional features, packages and technical specifications. Visit bmwusa.com, select the BMW model of your choice, and click on "Features & Specs."



Steering wheel-mounted paddle shifters allow you to shift gears manually without using a clutch, and are included with the 7-speed Double Clutch Transmission and the Sport Automatic transmission. **Heated steering wheel** makes gloves unnecessary in cold-weather driving. A flick of the switch quickly warms the steering wheel to the perfect temperature.



Driving Dynamics Control allows you to tailor the Z4's performance by selecting COMFORT, SPORT or SPORT+ driving modes at the touch of a switch. This changes throttle response, steering assist, suspension damping (with Adaptive M Suspension) and automatic transmission shifting (if so equipped). Additionally, you can deactivate Dynamic Stability Control (DSC) and switch to Dynamic Traction Control (DTC), which allows wheelslip within defined limits when driving in deep snow, or for a sportier driving style.
Adaptive M Suspension lowers the chassis by 0.4 inches and electronically adjusts the dampers from sportingly tight to relaxed and comfortable, for greater agility and precise response.



6-speed manual transmission is smooth and optimally synchronized. Developed specifically for the Z4 Roadster, it features precise, short-throw gear shifts for an athletic driving experience. The narrow transmission ratios with an additional sixth gear make the engine even more responsive to your personal driving style.



8-speed Sport Automatic transmission enhances the Z4 sDrive28i's athletic performance, with its quick gear shifts and immediate response to the accelerator pedal. In addition to Adaptive Transmission Control (ATC) that learns your driving style, it offers two manual shift modes: using the gear selector lever or the steering wheel-mounted paddle shifters, which are automatically included.

7-speed Double Clutch Transmission provides the Z4 sDrive35i and Z4 sDrive35i with smooth, lightning-quick gear changes by automatically shifting between two transmission structures. While one gear is disengaging, the next is already in position. The result is both quicker acceleration and enhanced fuel efficiency. (Includes steering wheel-mounted paddle shifters.)

Air conditioning provides an ideal environment year-round. Includes micro-filter, manual temperature adjustment and air recirculation, seven fan speeds, and knee-level vents.

Automatic climate control system allows each occupant to select their preferred temperature, as well as automatic or manual airflow and recirculation. The automatic recirculation control activates whenever certain air pollutants are detected. The system also offers a convertible mode for when the roof is down; micro-filter, defrost/dry and MAX A/C functions; sun and rain sensor; and auxiliary ventilation (shown here).



Premium Sound Package anti-theft AM/FM/CD player generates full-bodied sound. Two-line readout displays names, audio and MP3 tracks. Includes Sirius Satellite Radio with one-year subscription.

BMW anti-theft AM/FM stereo/CD/MP3 player (not shown) includes Radio Data System, reads/displays song title, Auto-Store and 3-channel FM diversity antenna.

HD Radio™ receives free, digital AM/FM broadcasts across the U.S. In clear, static-free quality sound – AM sounds like FM, FM sounds like CD. Also enjoy “multicast” FM stations, as well as a variety of innovative data services. For more information on HD Radio, visit HDRadio.com.

Premium speaker system fills the cabin with rich surround sound. The multi-channel digital amplifier adjusts the surround sound to the internal dimensions of the vehicle, when equipped with the Navigation system, sound can be adjusted to simulate a church, hall or jazz club.

Get the latest information on BMW standard and optional features and equipment. Visit www.bmwusa.com, select the BMW model of your choice, and click on “Features & Specs.”



Navigation system features a pop-up, high-resolution, glare-free monitor. When not in use, it retracts back down, out of sight. Features include 3-D daytime and nighttime maps, zoom, travel planner and an Assistance Window. The hard drive offers 12 GB of space that can hold up to 2,000 songs. It also provides Real Time Traffic information on potential traffic problems and solutions. **Voice command** allows you to select radio stations, Navigation destinations, initiate mobile phone calls (if so equipped) and more without taking your attention away from traffic.



BMW Assist™ comes with four years of the BMW Assist Safety Plan, providing Automatic Collision Notification, Emergency Request, Roadside Assistance, Door Unlock, Stolen Vehicle Recovery, Teleservice, MyInfo and more. The optional **BMW Assist Convenience Plan** offers Directions, Traffic, Weather, Critical Calling, Concierge services and BMW Online.

See page 60 for detailed information on standard and optional services available with BMW Assist.



Smartphone Integration lets you snap in your Bluetooth® enabled mobile phone to make hands-free calls while recharging. Includes a connection for the charger and external antenna for enhanced reception.

iPod® and USB adapter lets you scroll through and select the music you want by using the car's radio controls, the multi-function steering wheel buttons or Drive Controller. Music titles are displayed on the radio or Navigation screen.

Auxiliary input ports let you connect an external audio source, such as an iPod or MP3 player.



Through-loading system with integrated ski bag is an ideal way to expand the Z4 Roadster's stowing capabilities. It cleanly and securely holds two pairs of 67-inch skis and ski poles, or a 46-inch full-size golf bag. With the hardtop up, a second 46-inch golf bag can be stored in the trunk. When using the through-loading system, the removable cover can be locked in position.



Storage package, included in the Cold Weather Package, maximizes the Z4's carrying capabilities. In the cabin, fastening nets are located in the passenger's footwell area and behind the seatbacks; a handy clothes hook is on each roll bar. In the trunk, cargo can be held down by lashing belts, and there is a convenient partition storage compartment that fits into the throughload opening.



Storage options abound in the Z4. In addition to the storage bench behind the seats, there are fold-out storage compartments in both doors, two storage trays in the center console, a storage compartment in the dash (not available with Navigation system), one under the center console, and a spacious glove compartment.



Luggage compartment is surprisingly spacious for a roadster. With the hardtop down, the trunk holds 6.4 cu. ft. Put the top up, and it holds 10.9 cu. ft. – enough to hold a 46-inch golf bag. A movable partition, unique in the premium roadster class, creates enough room for a medium-size suitcase with the roof down – and much more with the roof up.

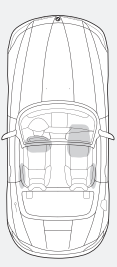

Front airbags help protect the head and upper body; **side airbags** significantly reduce the risk of injury to the head, thoracic and pelvic area in a side collision. If the passenger seat is unoccupied, these airbags are designed not to deploy. However, if a child seat is installed, these airbags must be manually deactivated. **Active knee protection** also helps protect knees in the event of severe impact.

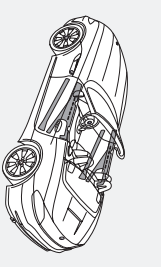

Door reinforcements are designed to provide maximum occupant protection in the event of a side impact. Added protection is provided by diagonal safety bars in the doors.

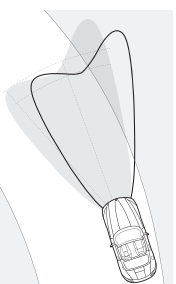

Xenon Adaptive Headlights automatically swivel to follow the curves of the road. The system uses data from on-board sensors and the steering wheel angle to determine the car's direction, then adjusts the headlights accordingly. The system offers outstanding nighttime visibility.

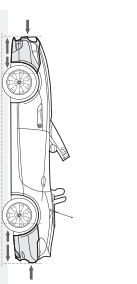

Impact-absorbing bumpers and compressible "crush tubes" front and rear help absorb the force of impact in collisions up to 9 mph, helping to minimize damage to the vehicle's body and simplifying repairs. Only at higher impact speeds do structural supports begin to deform, dissipating impact energy to help protect occupants.

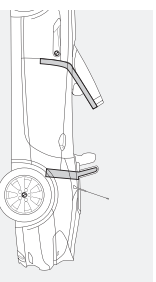

Z4 Roadster Rollover Protection System consists of two steel roll bars behind the headrests; they are connected with a highly stable chassis crossbeam. The system is completed by a bar of high-strength tubular steel integrated into the windshield frame for maximum safety.

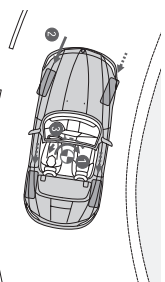

Cornering Brake Control (CBC) increases vehicle stability by proportioning the braking force while turning. When you brake in a turn, the pressure comes off the rear wheels, which (1) causes the vehicle to swerve inward (oversteer). Cornering Brake Control counteracts this action by asymmetrically adjusting brake pressure (2), creating stabilizing counter-torque (3) independently of the ABS system.

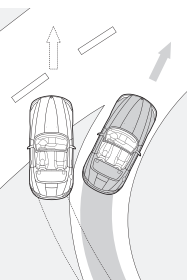

Dynamic Stability Control (DSC) is a braking control system that, when it senses an impending skid, helps to stabilize the vehicle in just milliseconds. If the system senses over- or understeer, it modulates engine power and/or applies brakes individually to help keep the Z4 under control and going in the intended direction. For sportier driving or in deep snow, manually activate Dynamic Traction Control (DTC), to allow increased wheelspin.

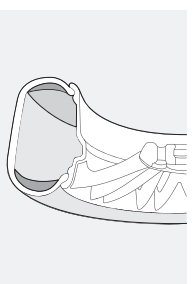

Run-flat tires allow speeds of up to 50 mph and travel from 30 to 150 miles after a loss of air pressure. In situations that would normally result in a flat tire, reinforced sidewalls help prevent the tires from collapsing or loosening from the rim. In the event of a decline in the pressure, the driver is warned by the **Tire Pressure Monitor**.

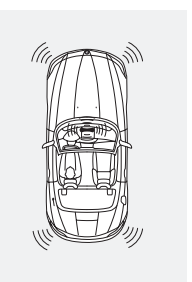

When **crash sensors** detect a serious impact, interior lights and hazard flashers activate, and the doors automatically unlock to allow access for emergency aid.

Get the latest information on BMW standard and optional features. Visit www.bmwusa.com, select the BMW model of your choice, and click on "Features & Specs."

We believe that a premium ownership experience should feature performance and luxury, as well as safety and convenience. We believe you should be able to drive a BMW to its potential, while enjoying peace of mind and reduced cost of ownership. That's the idea behind **BMW Ultimate Service**¹ – a suite of comprehensive programs and services that are included in every new BMW vehicle.

GOING BEYOND ENGINEERING: THE HIGH-PERFORMANCE BMW OWNERSHIP EXPERIENCE.

BMW Maintenance Program is one of the most comprehensive maintenance programs in its class. We cover all factory-recommended maintenance during the New Vehicle SAV Limited Warranty coverage period. This includes scheduled oil services and inspections. Also covered is the replacement of items that are subject to normal wear and tear, such as brake pads, wiper blade inserts and engine drive belts. And, thanks to BMW's advanced engineering, most owners enjoy a well-balanced maintenance schedule, with flexible routine service intervals that can save you time. When your vehicle requires attention, you'll be notified by BMW center resources that it receives only genuine BMW parts – your assurance of exacting quality standards.

For more details on BMW Ultimate Service and the BMW Maintenance Program, visit your authorized BMW center or log on to bmwusa.com/ultimateservice.

BMW Assist Safety Plan² is a four-year program that lets you enjoy peace of mind knowing that a friendly response specialist is there to help you, 24/7, at just the push of a button. The SAV Plan includes Automatic Collision Notification, Emergency Request, Enhanced Roadside Assistance, Door Unlock, Stolen Vehicle Recovery and Customer Relations. Included in the BMW Assist Safety Plan, MyInfo allows you to send status messages and street addresses with their associated phone numbers directly to your BMW. The destination can be sent to your Navigation system for turn-by-turn directions. With the BMW Navigation system and your mobile phone linked to your BMW via Bluetooth[®] technology, BMW's Mobile Office feature³ transfers text messages and emails to your Drive Display screen and reads them aloud to you. A Calendar and To-do List can also appear on your Drive Display screen while enroute. Running late? Click on the phone number in the Calendar to call your appointment. For a list of tested mobile phones, visit bmwusa.com/bluetooth.

BMW Ultimate Service starts with the **New Vehicle/SAV Limited Warranty**¹ providing you with coverage for the first four years or 50,000 miles, whichever comes first. Additionally, you have 12-year, unlimited-mileage warranty protection against corrosion and rust perforation.⁴ The **BMW Maintenance Program** and **BMW Roadside Assistance** also come standard, with **BMW Assist**² offered as an option.

For the ultimate in coverage, add the optional **BMW Assist Convenience Plan**. You'll enjoy unlimited access to personalized Directions, Traffic and Weather reports, as well as our Concierge feature, which can send a destination address and phone number, such as a restaurant or hotel, right to your BMW. You can make up to four operator-assisted calls per year with Critical Calling. If your cell phone is not available, or if its battery is discharged, BMW OnLine allows access to up-to-date fuel prices and the latest weather forecasts, as well as Bloomberg's stock indices and the powerful reach of the Google Maps database – delivered to the Drive Display right inside your vehicle.

BMW's unique **Teleservice**, included in the BMW Assist Safety Plan, continually monitors specific parts that are subject to wear and tear – including the engine oil, micro-filter, spark plugs, brake linings and various fluids – as well as services that require attention at regular intervals, such as vehicle service inspections. This data is automatically transmitted to your authorized BMW center, which

will then call you to schedule a service appointment. You don't have to keep track of when your vehicle requires routine maintenance. An added benefit: any needed maintenance services are already be on hand, so your BMW is serviced and returned to you as quickly as possible. And because they use only Original BMW Parts, you can rely on expert fit and long-lasting BMW quality. For more details on Teleservice, visit bmwusa.com.

BMW Roadside Assistance is provided free of charge for the first four years – with no mileage limit. Call **1-800-332-4BMW (4269)** for friendly on-the-road help, 24/7, anywhere in the United States, Canada and Puerto Rico. This includes everything from flat-tire changes, emergency gasoline and lock-out service, to towing, alternate transportation and even trip-interruption benefits. This service also provides valuable trip-routing advice.

BMW's unique **Teleservice**, included in the BMW Assist Safety Plan, continually monitors specific parts that are subject to wear and tear – including the engine oil, micro-filter, spark plugs, brake linings and various fluids – as well as services that require attention at regular intervals, such as vehicle service inspections. This data is automatically transmitted to your authorized BMW center, which

will then call you to schedule a service appointment. You don't have to keep track of when your vehicle requires routine maintenance. An added benefit: any needed maintenance services are already be on hand, so your BMW is serviced and returned to you as quickly as possible. And because they use only Original BMW Parts, you can rely on expert fit and long-lasting BMW quality. For more details on Teleservice, visit bmwusa.com.

THE MOST EXCITING PLACE IN AMERICA TO DRIVE A BMW.

The **BMW Performance Center in Spartanburg, SC**. Just beyond the foothills of the Carolinas' Blue Ridge Mountains lies the \$12 million BMW Performance Center. This sprawling, modern complex houses the world-famous BMW Performance Driving School, as well as the Zentrum Museum, BMW Boutique, BMW Delivery Center, and a Corporate Conference Center. Nearby is BMW's only manufacturing facility in the U.S., where models, such as the SAV,⁵ are built for export worldwide. It's a unique place where BMW enthusiasts can spend days – or, in the surrounding area, an entire vacation.

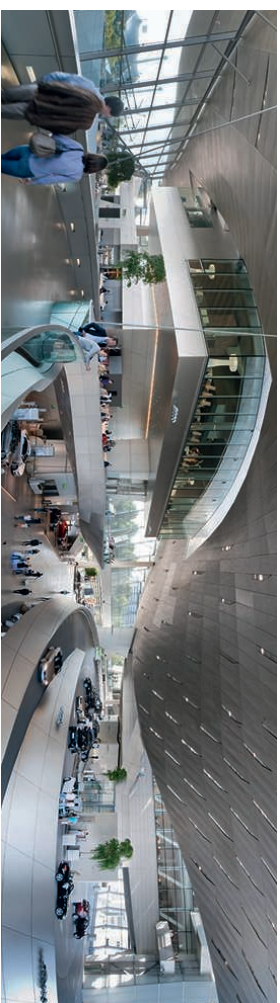

BMW Virtual Center. If you get the sudden urge to stop for a BMW but your authorized BMW center is closed, there's good news – the BMW Virtual Center is open 24 hours a day! Log on to bmwusa.com/vo, and choose the model that interests you. Configure the BMW of your dreams, and see what the monthly payments would be. You can even send the specifications to your authorized BMW center, apply for financing, or request a test drive – all online!

BMW Financial Services. Arranging to buy or lease a BMW is easier than you may think. Your authorized BMW center offers leasing and financing to suit your personal needs through BMW Financial Services. Start the process at our website, where you can build your "dream vehicle," get an estimate on a monthly lease or financing payment, submit a credit application to BMW Financial Services – and get approval – all online! To find out how BMW Financial Services can help put you behind the wheel of your favorite BMW model, log on to bmwusa.com/fts or call, toll-free, **1-800-578-5000**.

BMW Magazine. A fascinating view of the latest events and products in the world of BMW, including travel reviews, personality profiles, and the latest BMW technologies. Sent to new owners and lessees several times a year, you can also read articles from **BMW Magazine** on the BMW website at bmwusa.com under the "Media Gallery & Library" heading, found in the "Experience" section.

BMW Welt. The BMW Welt ("BMW World") delivery and brand-experience center in Munich is bold proof of BMW's passion for design. When you take advantage of the BMW European Delivery Program⁶, this is where you will meet your new BMW – in a personalized process that is highly dramatic and totally unforgettable. You might also realize substantial savings that just may pay for your trip! While you're there, marvel at the historic BMW's in the Museum, learn about our engineers' newest innovations in the Technology and Design Atelier, and take a tour of the plant to experience firsthand the state-of-the-art methods used to create a BMW. Then comes the unique experience of driving your new BMW on the roads those designed for. To learn more, visit bmwusa.com/europeandelivery.

BMW Performance Driving School. Whether you've been driving for decades or just got your learner's permit, we can help take your driving skills to the next level. Behind the wheel of our new BMWs and under the expert guidance of professional driving instructors, you'll hone your driving skills on a versatile driving course – 1.7 miles of asphalt that can be configured in a multitude of ways. In one- and two-day schools you can tackle the skid pad, slalom course and water walls. The BMW Performance Driving School is about control and pushing a BMW to its limits – and yours.

BMW Performance Center Delivery. You'll always remember the fun of taking delivery of your new BMW – with BMW Performance Center Delivery. After enjoying dinner and an overnight stay at a first-class hotel, we'll take you and your companion to the Performance Center where a Product Specialist will give you an in-depth introduction to your new BMW. Then at the Performance Driving School, you'll get tips from a professional driving instructor as you explore the dynamic capabilities of a similar model. It's exciting, it's enlightening – and it's all compliments of BMW with your new vehicle.

To learn more about the BMW Performance Center, call **888-345-4269** or visit bmwusa.com/performancecenter.

BMW Performance Center Delivery.

You'll always remember the fun of taking delivery of your new BMW – with BMW Performance Center Delivery. After enjoying dinner and an overnight stay at a first-class hotel, we'll take you and your companion to the Performance Center where a Product Specialist will give you an in-depth introduction to your new BMW. Then at the Performance Driving School, you'll get tips from a professional driving instructor as you explore the dynamic capabilities of a similar model. It's exciting, it's enlightening – and it's all compliments of BMW with your new vehicle.

To learn more about the BMW Performance Center, call **888-345-4269** or visit bmwusa.com/performancecenter.



More about BMW

bmwusa.com
1-800-334-4BMW



The Ultimate
Driving Machine®

BMW and the environment.

BMW is a strong proponent of the environment and social responsibility. We launched BMW Efficient Dynamics back in 2000 – the philosophy of providing greater power with increased efficiency and fewer emissions. This has resulted in significant benefits today – for our customers, the climate and the environment.

That year, ecological sustainability was also declared one of BMW's core strategic principles; it is now firmly anchored in our entire production chain. It starts with the development of fuel-saving and alternative vehicle concepts, continues with environmentally friendly production processes, and ends with innovative recycling methods. This effort has been recognized worldwide; in 1999, BMW AG – the parent company of BMW of North America and BMW Manufacturing Co. in Spartanburg, SC – was the first automotive company to be represented on the Dow Jones Sustainability Group Index. It has remained on the Index ever since; moreover, since 2005, BMW has been voted the world's most sustainable automobile manufacturer. At BMW, we strive for and achieve high performance in all we do.

U.S. Importer: BMW of North America, LLC, Woodcliff Lake, NJ 07677. All illustrations and specifications contained in this brochure are based on the latest product information available at the time of printing. BMW reserves the right to make changes at any time, without notice, in colors, materials, equipment, specifications and models. BMW may, subject to legal requirements, determine the Model Year designation of its vehicles. The Model Year designation on any particular model may be longer or shorter than 12 months. Some vehicles pictured may contain non-U.S. equipment. Some models may be shown with optional equipment. While BMW NA makes all reasonable efforts to provide accurate information in this brochure, there is no guarantee or warranty of accuracy. Furthermore, we do not assume any liability for the accuracy or completeness of information presented. This brochure shall not be used or relied upon as a substitute for information that is available from your BMW center. Further information can be obtained from your authorized BMW center or bmwusa.com.

©2011 BMW of North America, LLC. Not to be reproduced wholly or in part without written permission of BMW NA. The BMW name, logo, model names and SAV are registered trademarks.

The Bluetooth word mark and logos are owned by the Bluetooth SIG, Inc. and any use of such marks by BMW is under license. iPhone and iPod are registered trademarks of Apple Inc. Other trademarks and trade names are the property of their respective owners.

BMW recommends  **EDGE**